



SHARKFEST '13

Wireshark Developer and User Conference

Why is crypto so hard to get right?

Ron Bowes, Leviathan Security Group

Sharkfest 2013



About me



- Ron Bowes
 - @iagox86
 - <http://www.skullsecurity.org>
 - ron.bowes@leviathansecurity.com
- Security consultant for Leviathan Security Group
- Founder/president of SkullSpace, Winnipeg's hackerspace
- Rockclimber
 - The best way to improve your self confidence is to hang 1000ft in the air – from an anchor you built yourself!
 - This is probably more common in California, but I'm from the prairies!



Quick agenda

- History of crypto attacks
- A bunch of examples, with proofs of concept
 - Key re-use
 - Hash length extension
 - Padding oracle
- Some proposed solutions

Why am I doing this?

- In my opinion, crypto is one of the most important technologies in the modern world, if implemented correctly
- Crypto implementation is hard
- I decided to teach myself attacks by writing tools
 - Before I knew it, I had enough to make an interesting talk!

Why am I doing this?

- The four stages of competence:
 - **Unconscious incompetence** - When you don't know how bad you are or what you don't know.
 - **Conscious incompetence** - When you know how bad you are and know what steps you need to take to get better.
 - **Conscious competence** - When you're good and you know it (this is fun!)
 - **Unconscious competence** - When you're so good you don't know it anymore.
- I went to help people go from **Unconscious incompetence** to **Conscious incompetence**!
- Source:
<http://happybearsoftware.com/you-are-dangerously-bad-at-cryptography.html>

Why am I doing this?

- One more quote from the page, then I'll move on:
"Cryptography is perilous because you get no feedback when you mess up. For the average developer, one block of random base 64 encoded bytes is as good as any other."
"You can get good at programming by accident. If your code doesn't compile, doesn't do what you intended it to or has easily observable [sic] bugs, you get immediate feedback, you fix it and you make it better next time."
"You cannot get good at cryptography by accident."

Why am I doing this?

- Another great talk: "If You're Typing The Letters A-E-S Into Your Code, You're Doing It Wrong"
 - <http://www.cs.berkeley.edu/~daw/teaching/cs261-f12/misc/if.html>
 - Hey look, it's berkeley!
 - Same information, same conclusion, as both the previous post and this talk!
 - A fun, interesting read! One of my first forays into crypto.



The somewhat accurate

HISTORY OF CRYPTO

c. 75 BC: Caesar cipher

- Shift cipher
- 25 possible encodings (26, if you count '0')
- Trivially bruteforced

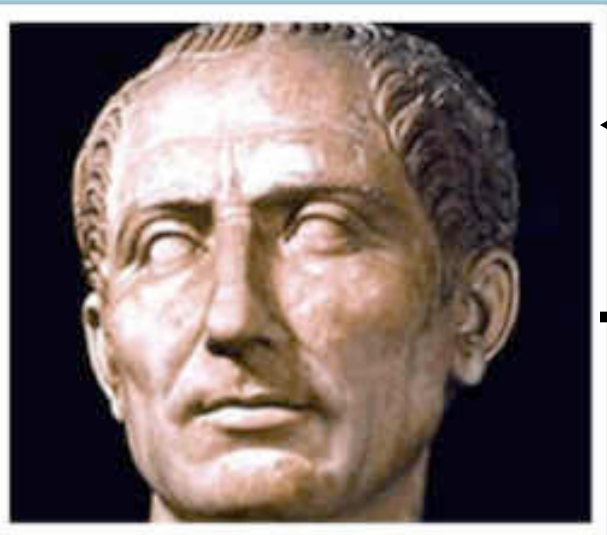

J uijol nz gsjfoet bsf uszjoh up ljmm nf!

mpm



Caesar – World War II: No developments

File: [1359396104253.jpg](#) (17 KB, 220x293, 220px-EnigmaMachineLabeled.jpg)



Anonymous (ID: kv30XfOr) 01/28/13(Mon)13:01:44 No.454378465

Hey 4chan, I need help writing a paper! Were there any important developments in cryptography between the Caesar Cipher and the Enigma Machine?

>> **Anonymous** (ID: nijl5aT4) 01/28/13(Mon)13:02:33 No.454378583

No.

The End.

You're welcome.

[\[Return\]](#) [\[Catalog\]](#) [\[Top\]](#) [\[Update\]](#) (Auto)

World War II: Enigma Machine

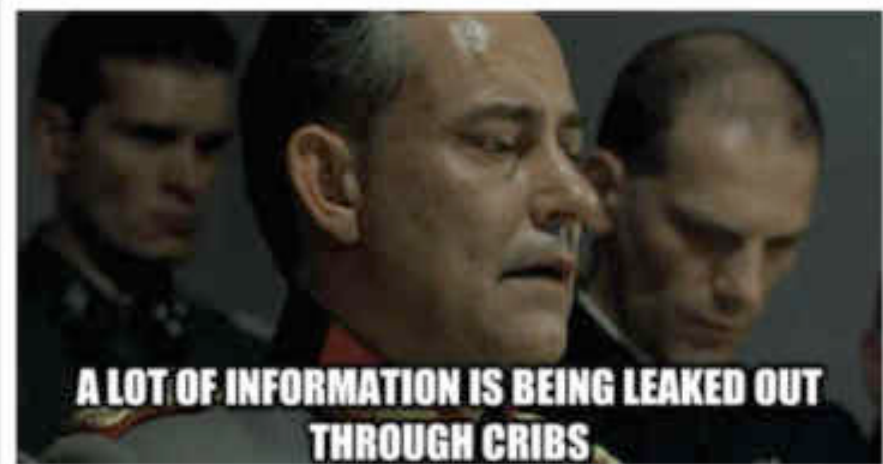

Let's get more modern



1970s: DES was invented!

- A symmetric-key block cipher
- Message could be decrypted by the intended recipient and everybody who's stolen the key

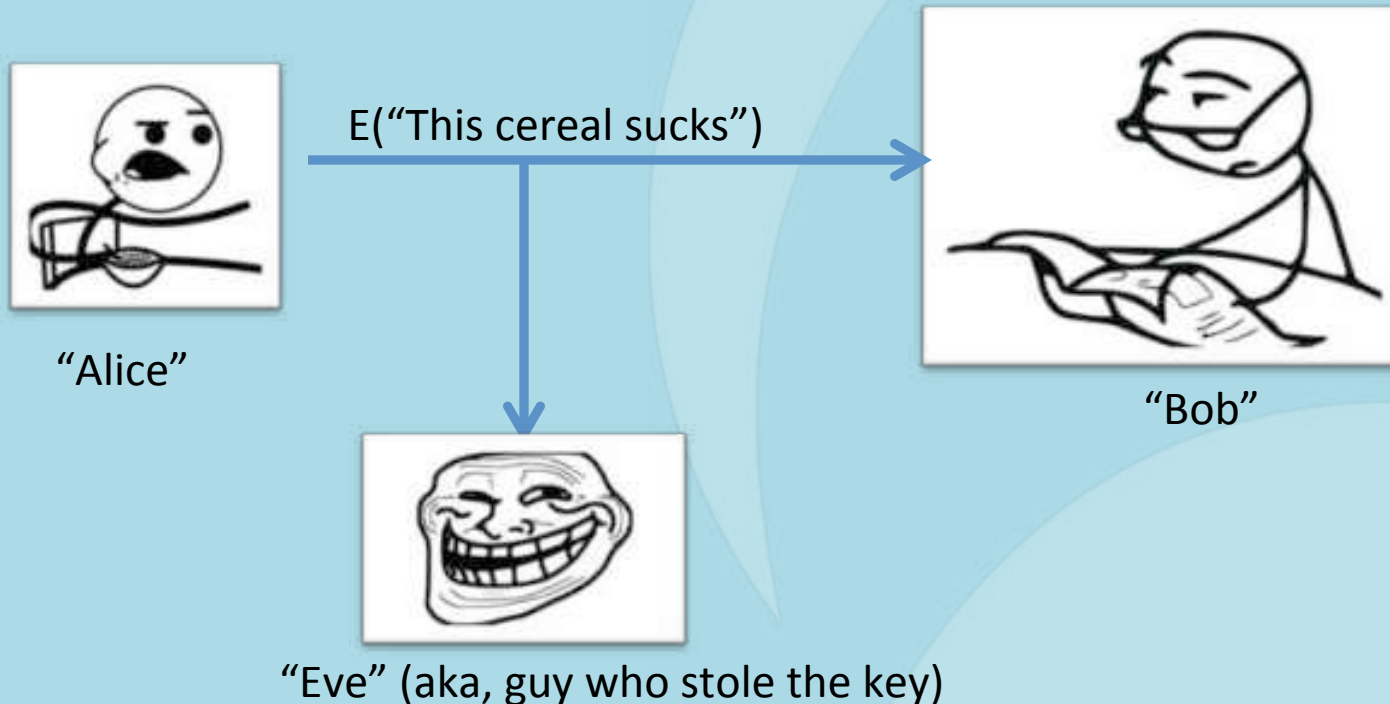

Still 1970s: Along came DH and RSA

- Now both parties have to exchange keys with “Eve” (or each other) before they can communicate



1990s: Certification Authorities

- Now you can see if any of 100s of companies thinks the “Bob” is actually “Bob”



“Eve”

K_{eve}



“Alice”

Is this K_{bob} ?

Sure, whatever



?

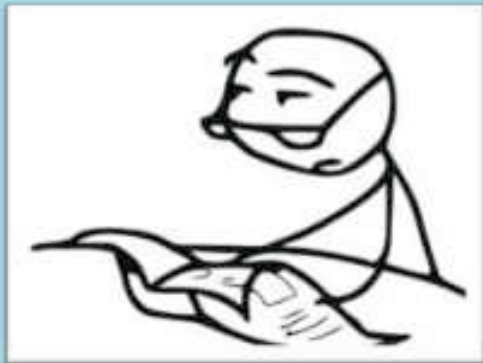

“Bob”

1990s: WEP

- While we're talking about Goatse...
- RC4 w/ 24-bit IV
- Using RC4 all kinds of wrong led to total compromise

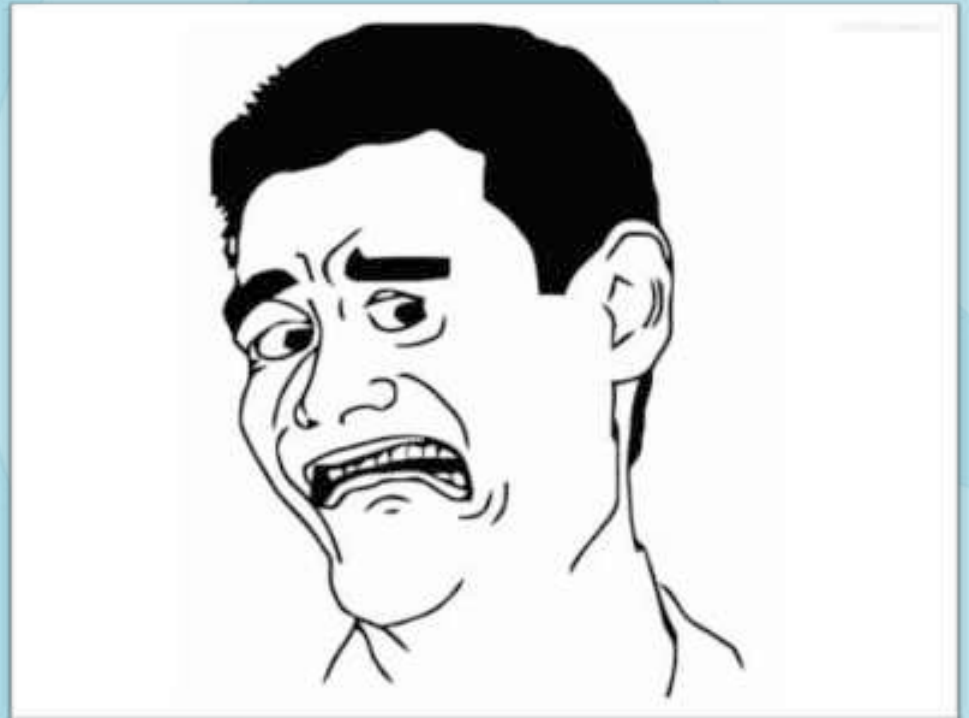

2008: github (and other “Web 2.0” stuff)

- A new place for people to post private keys, passwords, and other confidential data

A screenshot of a file viewer window. The title bar shows 'file | 17 lines (14 sloc) | 0.37 kb'. The main content area displays an RSA private key in PEM format. The key is enclosed in a dashed box with the text '== RSA ==' at the bottom. The key is preceded by '-----BEGIN RSA PRIVATE KEY-----' and followed by '-----END RSA PRIVATE KEY-----'. The key data is on 16 lines, with line 10 containing a large block of base64-encoded text. The viewer has a line number column on the left side.

```
1 -----BEGIN RSA PRIVATE KEY-----  
2 Proc-Type: 4,ENCRYPTED  
3 DEK-Info: DES-EDE3-CBC,CAFEBABE  
4  
5  
6  
7  
8  
9  
10  
11  
12  
13  
14 == RSA ==  
15  
16 -----END RSA PRIVATE KEY-----
```

Point?

- These days, encryption is rarely broken directly
- It's broken by...
 - Implementation error (developer mistakes)
 - Operator error (end-user mistakes)
 - Document, key, codebook theft/leakage
 - Stupidity (aka, CAs)
 - Side-channel attacks
- The rest of this talk will be about indirect ways to break state-of-the-art crypto!



IMPORTANT CONCEPTS

Encryption

- The act of obscuring data using a secret key, such that only the intended recipient – and anybody else who manages to steal the key – can read it

Encryption: Block cipher

- Plaintext is broken into 8- or 16-byte blocks, each is encrypted individually
- Various “modes of operation” can be used to ensure that the ciphertext isn’t repeated

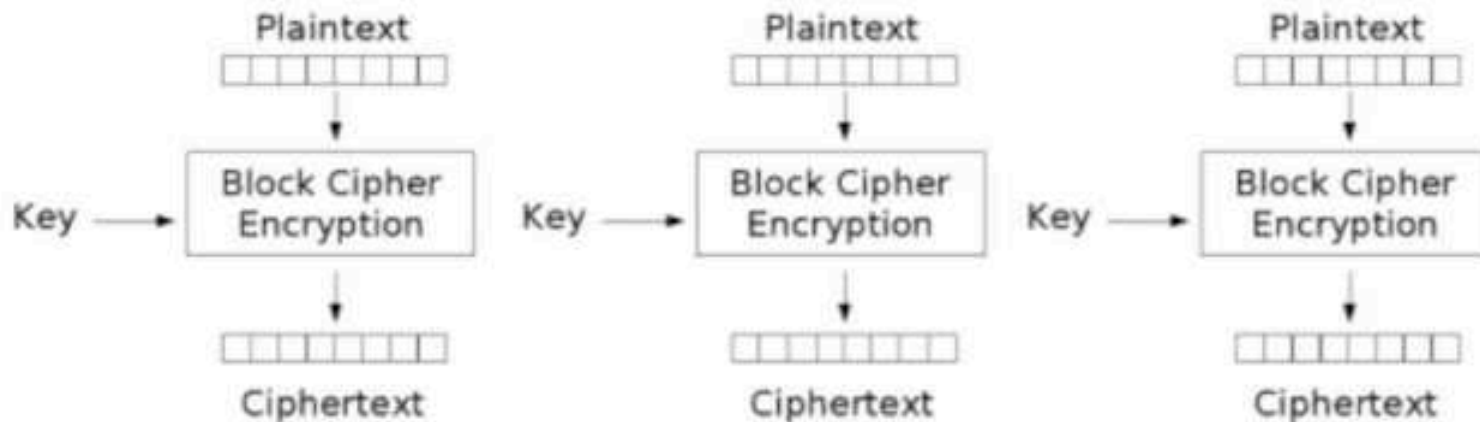

Electronic Codebook (ECB) mode encryption

Encryption: Block cipher modes of operation

– ECB

- “Electronic codebook” mode encrypts each block individually:

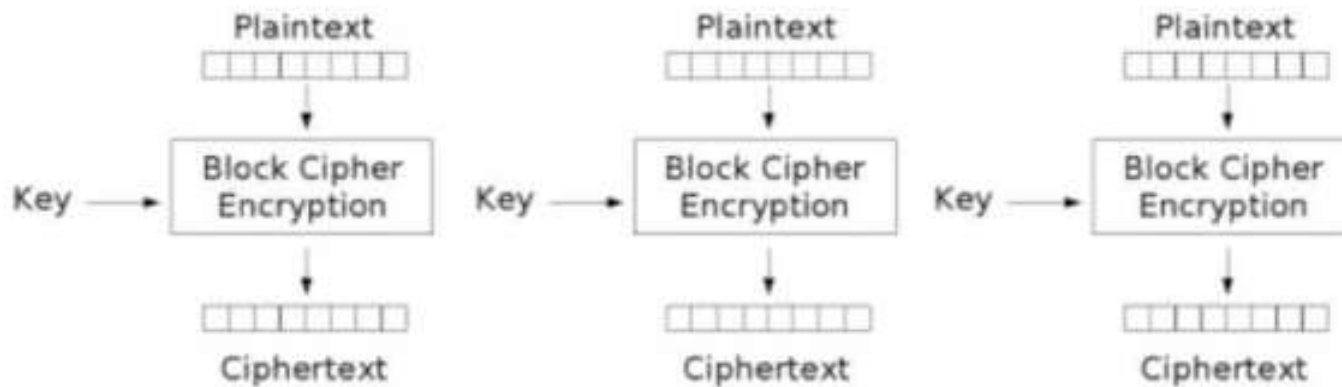

Electronic Codebook (ECB) mode encryption

- This leads to problems like the famous “ECB Tux” image:



Encryption: Block cipher modes of operation

– CBC

- “Cipherblock Chaining” feeds the output from each block into the input of the next:

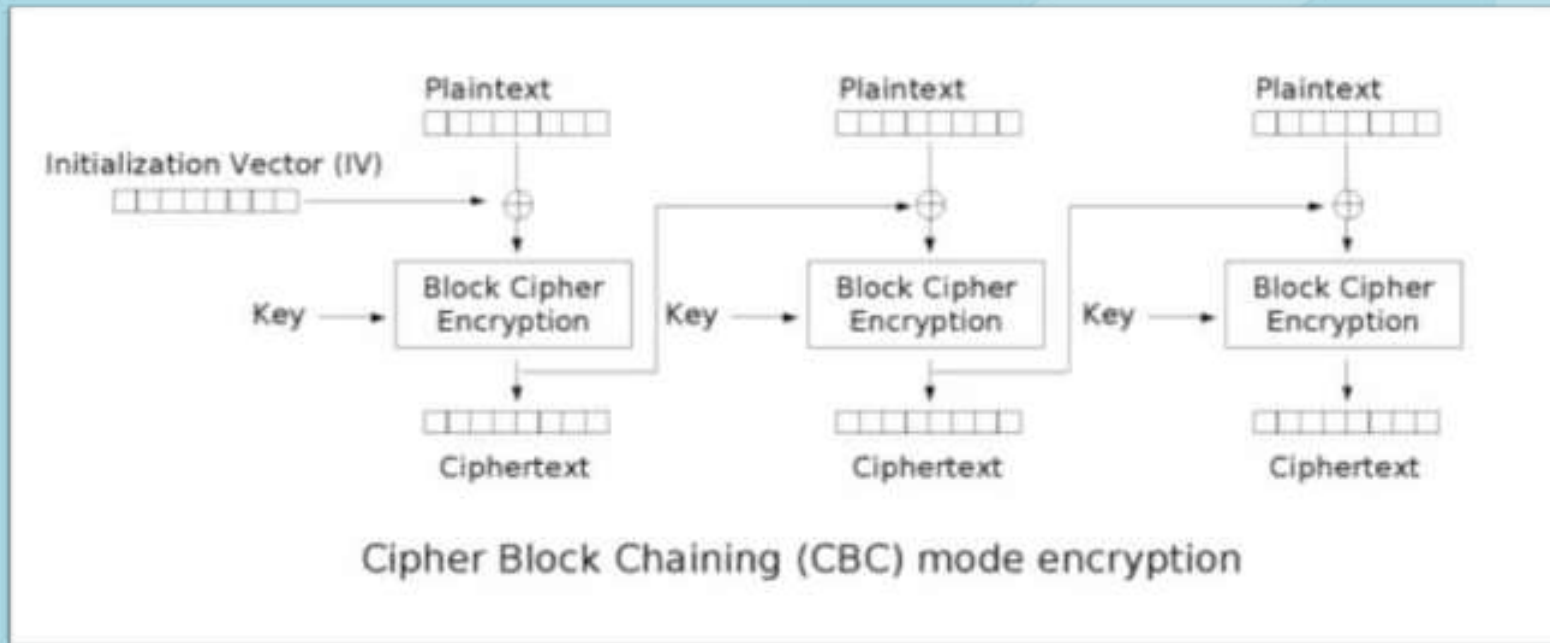

- This is much better than CBC, but also has some serious problems
- We'll talk about this in detail when we talk about padding oracles

Initialization vectors: IVs

- The 'input' into an encryption function
- Designed so that the same data encrypted with the same key doesn't generate the same ciphertext
- We'll see why that's a problem

Hashing

- Reducing a large amount of data to a small amount
- Works similarly to a block cipher, as we'll see

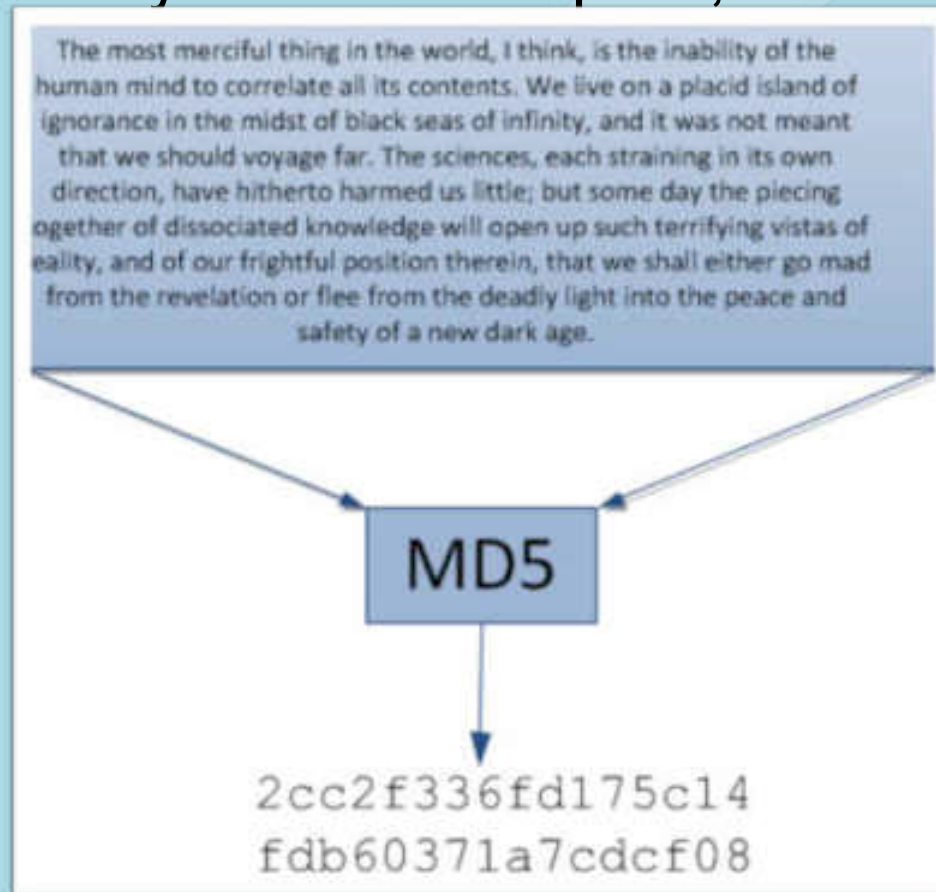

Now, what you all came here for...

ATTACKS



KEY RE-USE IN BLOCK CIPHERS

Key re-use in block ciphers

- Using the same key/IV to encrypt two messages = fail
- This affects:
 - DES (all modes)
 - 3DES (all modes)
 - AES (all modes)
 - RC2
 - RC4
 - RC5
 - And... well, everything else I've tested

Key re-use in block ciphers: When does this work?

- This attack works if:
 - Any normal cipher is used (block or stream)
 - Note that there are better ways to attack stream ciphers
 - The attacker controls at least [blocksize] bytes of the plaintext, preferably at the beginning
 - Note that only bytes after the attacker-controlled text can be decrypted
 - The same key and IV are used each time the encryption happens
 - Note that some ciphers – like ECB – don't have IVs, so this attack cannot be prevented

Key re-use in block ciphers – the setup

- Here's our “oracle”:

```
1 require 'openssl'
2
3 def do_crypto(prefix)
4   c = OpenSSL::Cipher::Cipher.new("DES-ECB")
5   c.encrypt
6   c.key = "MYDESKEY"
7   return c.update("#{prefix}This is some test data") + c.final
8 end
```

- Note that we're using “DES-ECB” – this attack will work, as-is, with every block and stream cipher in almost every “mode”
- ECB is somewhat special because it can't be fixed
 - We'll talk about ECB, CBC, etc. when we talk about padding oracles

Key re-use in block ciphers: example [1]

- Here's the output from `do_crypto("A" * 16)`:

| | | | | | | | | | |
|----------------------|------|------|------|------|------|------|------|------|--|
| P₁ | 'A' | 'A' | 'A' | 'A' | 'A' | 'A' | 'A' | 'A' | Two blocks of just "A"s (note that the ciphertext is the same) |
| C₁ | \x74 | \x31 | \xe1 | \xf0 | \xc6 | \x1b | \x35 | \x11 | |
| P₂ | 'A' | 'A' | 'A' | 'A' | 'A' | 'A' | 'A' | 'A' | |
| C₂ | \x74 | \x31 | \xe1 | \xf0 | \xc6 | \x1b | \x35 | \x11 | |
| P₃ | 'T' | 'h' | 'i' | 's' | ' ' | 'i' | 's' | ' ' | The rest of the string encrypted as-is |
| C₃ | \x35 | \x13 | \x7b | \x27 | \xb6 | \xf5 | \xda | \x9c | |
| P₄ | 's' | 'o' | 'm' | 'e' | ' ' | 't' | 'e' | 's' | |
| C₄ | \xb1 | \x0e | \xdf | \x42 | \x93 | \xe8 | \x17 | \x42 | |
| P₅ | 't' | ' ' | 'd' | 'a' | 't' | 'a' | \x02 | \x02 | |
| C₅ | \xe0 | \x6f | \xcf | \xc0 | \xcf | \xfe | \x87 | \x66 | |

Key re-use in block ciphers: example [2]

- Here's the output from `do_crypto("A" * 7)`:

| | | | | | | | | | |
|----------------------|------|------|------|------|------|------|------|------|---|
| P₁ | 'A' | 'A' | 'A' | 'A' | 'A' | 'A' | 'A' | 'T' | |
| C₁ | \xea | \xca | \x59 | \x30 | \x3d | \x8b | \xe6 | \x0f | ← GOAL |
| P₂ | 'h' | 'i' | 's' | ' ' | 'i' | 's' | ' ' | 's' | Stuff That We Don't Care About |
| C₂ | \xf2 | \xaa | \xb1 | \xfb | \x54 | \xb4 | \xb5 | \x87 | |
| P₃ | 'o' | 'm' | 'e' | ' ' | 't' | 'e' | 's' | 't' | |
| C₃ | \x34 | \x87 | \x06 | \x80 | \x9a | \xcc | \xad | \x43 | |
| P₄ | ' ' | 'd' | 'a' | 't' | 'a' | \x03 | \x03 | \x03 | ... |
| C₄ | \xd3 | \x71 | \x2a | \xf5 | \x79 | \x10 | \x25 | \xea | ... |
| P₁ | 'A' | 'A' | 'A' | 'A' | 'A' | 'A' | 'A' | 'T' | ... |
| C₁ | \xea | \xca | \x59 | \x30 | \x3d | \x8b | \xe6 | \x0f | ... |

Key re-use in block ciphers: example [3]

Goal:

| | | | | | | | | |
|-------|------|------|------|------|------|------|------|------|
| P_1 | 'A' | 'A' | 'A' | 'A' | 'A' | 'A' | 'A' | 'T' |
| C_1 | \xea | \xca | \x59 | \x30 | \x3d | \x8b | \xe6 | \x0f |

← We're trying to find a match for this

- It's pretty trivial to guess a single byte...
 - ['A'..'Z' + 'a'..'z'] do |c| do_crypto('AAAAAAA' + c); end

Note: I'm only showing the first block or two

| | | | | | | | | |
|-------|------|------|------|------|------|------|------|------|
| P_1 | 'A' | 'A' | 'A' | 'A' | 'A' | 'A' | 'A' | 'S' |
| C_1 | \x1c | \x32 | \x22 | \x39 | \xb7 | \x99 | \x73 | \x42 |

← Nope

| | | | | | | | | |
|-------|------|------|------|------|------|------|------|------|
| P_2 | 'T' | 'h' | 'i' | 's' | ' ' | 'i' | 's' | ' ' |
| C_2 | \x35 | \x13 | \x7b | \x27 | \xb6 | \xf5 | \xda | \x9c |

| | | | | | | | | |
|-------|------|------|------|------|------|------|------|------|
| P_1 | 'A' | 'A' | 'A' | 'A' | 'A' | 'A' | 'A' | 'T' |
| C_1 | \xea | \xca | \x59 | \x30 | \x3d | \x8b | \xe6 | \x0f |

← Oh hai!

| | | | | | | | | |
|-------|------|------|------|------|------|------|------|------|
| P_1 | 'A' | 'A' | 'A' | 'A' | 'A' | 'A' | 'A' | 'U' |
| C_1 | \x5a | \x3c | \x17 | \x25 | \xc8 | \x0f | \x68 | \x3f |

← Nope

Key re-use in block ciphers: example [4]

- Here's the output from `do_crypto("A" * 6)`:

| | | | | | | | | | |
|-------|------|------|------|------|------|------|------|------|---|
| P_1 | 'A' | 'A' | 'A' | 'A' | 'A' | 'A' | 'T' | 'h' | |
| C_1 | \xcb | \x7a | \x74 | \xd0 | \x38 | \x45 | \xbf | \x21 | ← GOAL |
| P_2 | 'i' | 's' | ' ' | 'i' | 's' | ' ' | 's' | 'o' | Stuff That We Don't Care About |
| C_2 | \xf9 | \x8e | \xcd | \xdf | \x49 | \xf0 | \x86 | \xcb | |
| P_3 | 'm' | 'e' | ' ' | 't' | 'e' | 's' | 't' | ' ' | |
| C_3 | \x70 | \x8c | \xc0 | \x1d | \xe5 | \xf2 | \xdc | \x01 | |
| P_4 | 'd' | 'a' | 't' | 'a' | \x04 | \x04 | \x04 | \x04 | |
| C_4 | \xb4 | \x74 | \xfc | \x99 | \xd9 | \xbe | \xd2 | \x70 | |
| P_1 | 'A' | 'A' | 'A' | 'A' | 'A' | 'A' | 'T' | 'h' | |
| C_1 | \xcb | \x7a | \x74 | \xd0 | \x38 | \x45 | \xbf | \x21 | |

Key re-use in block ciphers: example [5]

| | | | | | | | | |
|----------------|------|------|------|------|------|------|------|------|
| P ₁ | 'A' | 'A' | 'A' | 'A' | 'A' | 'A' | 'T' | 'h' |
| C ₁ | \xcb | \x7a | \x74 | \xd0 | \x38 | \x45 | \xbf | \x21 |

← We're trying to find a match for this

- Once again, we're guessing a single byte:
 - ['A'..'Z' + 'a'..'z'] do |c| do_crypto('AAAAAAT' + c); end

Note: I'm only showing the first block or two

| | | | | | | | | |
|----------------|------|------|------|------|------|------|------|------|
| P ₁ | 'A' | 'A' | 'A' | 'A' | 'A' | 'A' | 'T' | 'g' |
| C ₁ | \xbb | \x48 | \x96 | \xa3 | \xb9 | \xb5 | \xc4 | \x32 |

← Nope

| | | | | | | | | |
|----------------|------|------|------|------|------|------|------|------|
| P ₂ | 'T' | 'h' | 'i' | 's' | '' | 'i' | 's' | '' |
| C ₂ | \x35 | \x13 | \x7b | \x27 | \xb6 | \xf5 | \xda | \x9c |

| | | | | | | | | |
|----------------|------|------|------|------|------|------|------|------|
| P ₁ | 'A' | 'A' | 'A' | 'A' | 'A' | 'A' | 'T' | 'h' |
| C ₁ | \xcb | \x7a | \x74 | \xd0 | \x38 | \x45 | \xbf | \x21 |

← Oh hai!

| | | | | | | | | |
|----------------|------|------|------|------|------|------|------|------|
| P ₁ | 'A' | 'A' | 'A' | 'A' | 'A' | 'A' | 'T' | 'i' |
| C ₁ | \x79 | \xc2 | \x04 | \x11 | \x64 | \xd0 | \xae | \xc2 |

← Nope

Key re-use in block ciphers: What's going on?

- We continue likewise till we've decrypted the entire packet
- What's going on?
 - We're forcing the first unknown byte to be on a block boundary, then guessing it
 - We can guess any character in 256 guesses, as long as we know all the characters before it

Key re-use in block ciphers: A tool!

- I wrote a tool called “Prephixer” to implement this attack
 - <https://www.github.com/iagox86/prephixer>
- Let’s do a demo!



Preventing key re-use in block ciphers

- Use different initialization vectors (IVs) when encrypting data
- If possible, use a different key (not always possible)
- If you're using ECB mode.... **WHY ARE YOU USING ECB MODE!?**

HASH LENGTH EXTENSION ATTACKS



Hash length extension attacks

- This is why I became interested in crypto attacks
- The basic idea: most hash algorithms (before SHA3) can “pick up where they left off”
- What’s that mean for security?
 - Let’s find out!

Hash length extension: the setup

- This is an attack where the following happens:
- Server calculates the following value:

```
verifier = H(secret || data)
```

The "Bad" operations are in red

- Then sends that verifier and data to the user
- Later, when the user sends the data back, it uses the verifier to ensure the data hasn't changed

```
if(H(secret || new_data) != verifier)
    throw error()
else
    trusted_operation(attacker_data)
```

How hashing works...

Let's look at an example...

```
SHA1("The most merciful thing in the world, I think, is the inability of the human mind to correlate all its contents. We live on a placid island of ignorance in the midst of black seas of infinity, and it was not meant that we should voyage far. The sciences, each straining in its own direction, have hitherto harmed us little; but some day the piecing together of dissociated knowledge will open up such terrifying vistas of reality, and of our frightful position therein, that we shall either go mad from the revelation or flee from the deadly light into the peace and safety of a new dark age.")
```

First, the string is broken into 64-character blocks (for SHA1):

```
"The most merciful thing in the world, I think, is the inability "  
"of the human mind to correlate all its contents. We live on a pl"  
"acid island of ignorance in the midst of black seas of infinity,"  
" and it was not meant that we should voyage far. The sciences, e"  
"ach straining in its own direction, have hitherto harmed us litt"  
"le; but some day the piecing together of dissociated knowledge w"  
"ill open up such terrifying vistas of reality, and of our fright"  
"ful position therein, that we shall either go mad from the revel"  
"ation or flee from the deadly light into the peace and safety of"  
" a new dark age."
```

How hashing works

- Padding is added to the last block:

```
"The most merciful thing in the world, I think, is the inability "  
"of the human mind to correlate all its contents. We live on a pl"  
"acid island of ignorance in the midst of black seas of infinity,"  
" and it was not meant that we should voyage far. The sciences, e"  
"ach straining in its own direction, have hitherto harmed us litt"  
"le; but some day the piecing together of dissociated knowledge w"  
"ill open up such terrifying vistas of reality, and of our fright"  
"ful position therein, that we shall either go mad from the revel"  
"ation or flee from the deadly light into the peace and safety of"  
" a new dark age.\x80\x00\x00\x00\x00\x00\x00\x00\x00\x00.....\x12\x80"
```

- The padding is equal to a 1-bit followed by a bunch of zero bits (“\x80\x00\x00\x00....”) followed by the length in bits
- The last eight bytes are equal to the length of the string (0x250 bytes) in bits (0x1280 bits)

Hash extension: And here we are!

- Let's say that again, to make sure we're clear: we just calculated the checksum for:
 - `(original_text || padding || "Hello? Yes, this is dog.")`
- Knowing only:
 - The output of the original hash function:
 - `ed8873c1 07d882b7 b6fcbbc1 9a272d61 4cf9e7ee`
 - And the text we wanted to add!
- We did *not* need to know `original_text`!

"||" is the "concatenate" operator in crypto.
@mak_kolybabi yells at me if I don't use it.

Hash extension: Applying it

- Flickr used to have an API something like this:
 - `message = SHA1(shared_secret || commands) + commands`
- Where `shared_secret` = the user's key (aka, a password)
- Example:
 - `message = SHA1("secretkey" + "name=ron") + "name=ron"`
 - `message = "\x0e\x78\x45\x47\x5d\xbe\x78\x41\x54\xe1\x55" + "\x36\x5d\xff\xf4\xe5\x4b\x15\x66\xa8name=ron"`

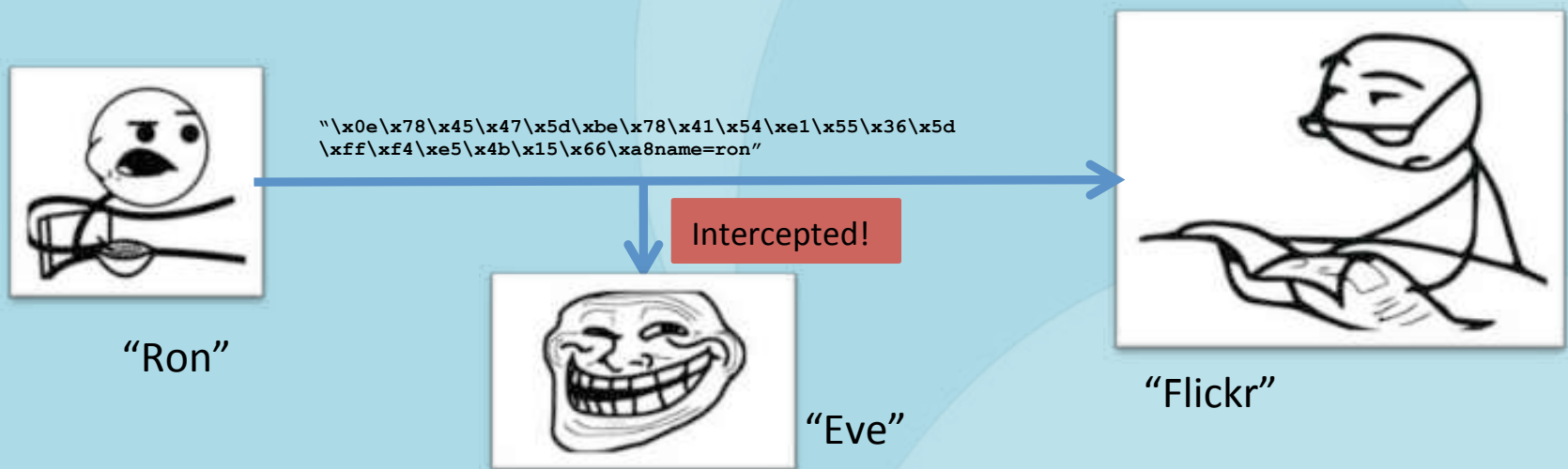

Hash extension: evil client

```
1 #include <stdio.h>
2 #include <openssl/sha.h>
3
4 int main(int argc, const char *argv[])
5 {
6     SHA_CTX ctx;
7     uint8_t buf[SHA_DIGEST_LENGTH];
8     size_t i;
9
10    SHA1_Init(&ctx);
11    ctx.h0 = 0x0e784547;
12    ctx.h1 = 0x5dbe7841;
13    ctx.h2 = 0x54e15536;
14    ctx.h3 = 0x5dfff4e5;
15    ctx.h4 = 0x4b1566a8;
16    ctx.N1 = 512;
17
18    SHA_Update(&ctx, "&deletemyaccount=1", 18);
19    SHA1_Final(buf, &ctx);
20
21    for(i = 0; i < SHA_DIGEST_LENGTH; i++)
22        printf("%02x", buf[i]);
23    printf("\n");
24
25    return 0;
26 }
```

← Eve writes
this
program

Looks right!

\$ gcc -o test test.c -lssl -lcrypto
\$./test

d281ac3cf91dbb960ec12c4e0e5d73bd91be6f10

Hash extension: Evil client -> legit server

- Eve then sends the following to the server:

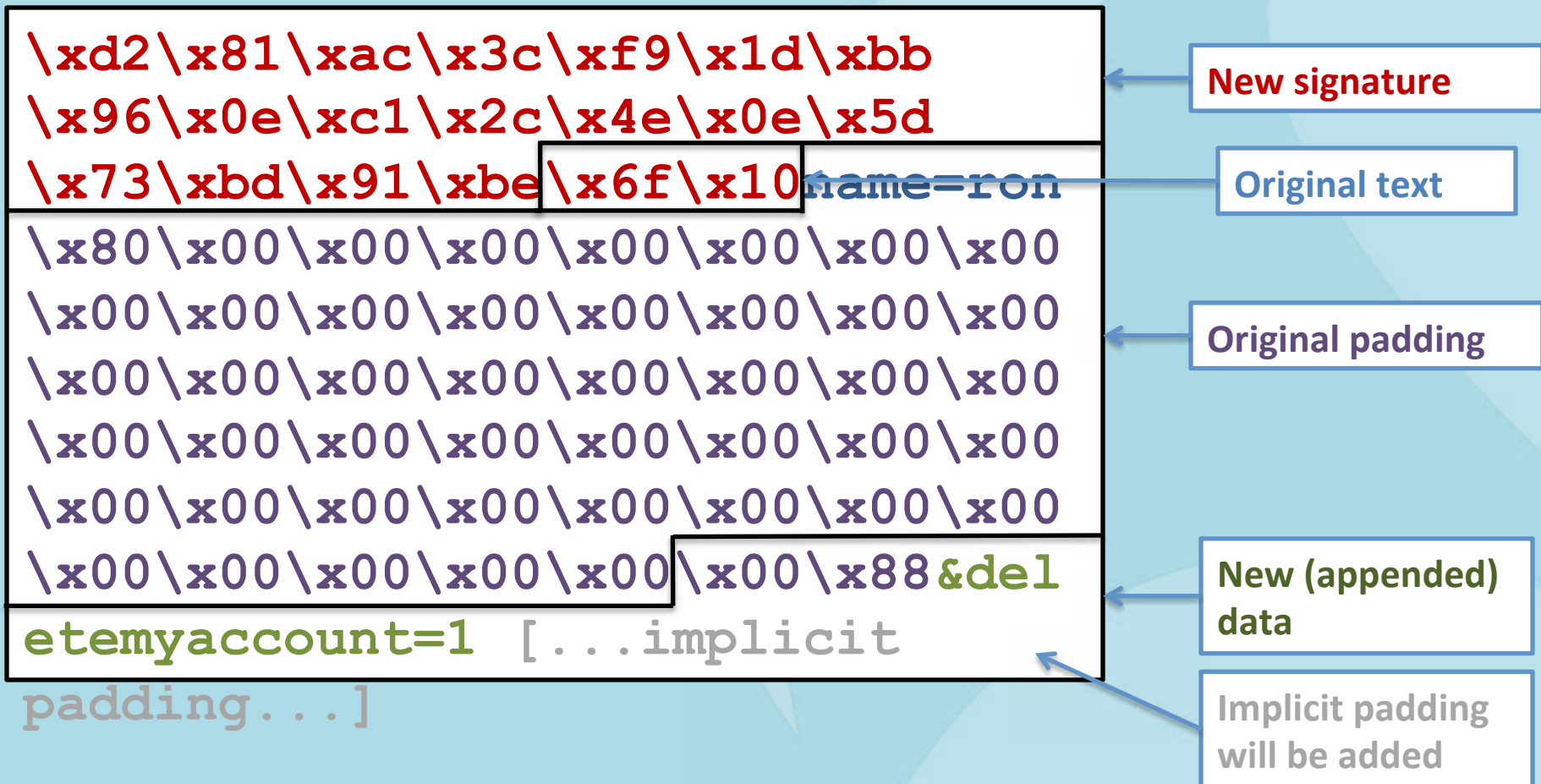

Hash extension: Legit server

- The legit server prepends the secret key to the data Eve sent, and calculates the hash:

```
1.9.3p194 :002 > require 'openssl'  
=> true  
1.9.3p194 :004 > Digest::SHA1.hexdigest("secretkey" + "name=  
ron  
\x80\x00\x00\x00\x00\x00\x00\x00\x00\x00\x00\x00\x00\x00\x00\x00  
\x00\x00\x00\x00\x00\x00\x00\x00\x00\x00\x00\x00\x00\x00\x00\x00  
\x00\x00\x00\x00\x00\x00\x00\x00\x00\x00\x00\x00\x00\x00\x00\x00  
\x00\x88&deletemyaccount=1")  
=> "d281ac3cf91dbb960ec12c4e0e5d73bd91be6f10"
```

Remember what
Eve calculated!

```
$ gcc -o test test.c -lssl -lcrypto  
$ ./test
```

```
d281ac3cf91dbb960ec12c4e0e5d73bd91be6f10
```

Hash extension: A tool!

- It's amazingly difficult to write these attacks by hand
 - I never fail to mess up the number of zeroes, or forget to convert the length to bits, or screw up endianness
- Luckily, you don't have to! I wrote `hash_extender` to take care of that
- `hash_extender` supports the following hashes:
 - **MD4, MD5, RIPEMD160, SHA, SHA1, SHA256, SHA512, Whirlpool**
- The following hash types are more difficult to extend, because the state is truncated before being used:
 - **SHA224, SHA384**
- And, the following hash type is impossible to extend, by design, although time will tell:
 - **SHA3**

That was a lot of material...

- So let's look at some cats then do a demo



Hash extension: summary

- If an attacker has access to a hash in the form of:
 - $H(\text{secret} + \text{“knowndata”})$
- He can trivially calculate:
 - $H(\text{secret} + \text{“knowndata”} + \text{padding} + \text{anything})$

Hash extension: Defense

- HMAC.
- Next topic.



DANGER



**MATH
AHEAD**

PADDING ORACLES



Padding oracles

- Hash extension attacks are fairly simple to understand – you just have to realize that hashes can “pick up where they left off”
- Padding oracles, on the other hand, require a bit more of a leap
- That being said, let’s do it!

Padding oracles: Overview

- Not to be confused with the Oracle database...
- This isn't an attack against any particular algorithm, but against cipher-block chaining (CBC)
- Invented by Serge Vaudenay in the early 2000s, also called the "Vaudenay attack"
- A padding oracle attack occurs when an attacker has encrypted and unknown data that he can ask a server to secretly decrypt
 - The data is a block cipher (DES, AES, etc) in CBC mode
 - The server doesn't give indication as to what the plaintext data is
 - The returns a boolean value indicating whether the decryption succeeded (which is based on the padding)

Padding oracles: Padding

- We already talked about padding on hashes, but this is different
- Block ciphers require the data to be padded such that it's a multiple of the blocksize
 - If the data is already a multiple, an empty block is added
- It doesn't matter what the padding is, just that it's known and unambiguous
- Let's look at the most common...

Padding oracles: Padding

- Typically, PKCS #7 is used, which says...
 - The value of the padding = the number of bytes of padding
- Eg (assume block size = 8 [DES, for example]):

| | | | | | | | | | | | | | | | | | |
|---------|---|---|---|---|------|------|------|---------|------|------|------|------|------|------|------|------|------|
| H | e | l | l | o | \x03 | \x03 | \x03 | | | | | | | | | | |
| H | e | l | l | o | | W | o | r | l | d | \x05 | \x05 | \x05 | \x05 | \x05 | | |
| P | a | s | s | w | o | r | d | \x08 | \x08 | \x08 | \x08 | \x08 | \x08 | \x08 | \x08 | \x08 | \x08 |
| Block 1 | | | | | | | | Block 2 | | | | | | | | | |

Padding oracles: CBC mode encryption

- Now that we've looked at padding, let's look at how the blocks fit together
- We already talked about electronic codebook (ECB) and cipher-block chaining (CBC)
- The “padding oracle attack” is actually an attack against CBC
- Let's see why...

Padding oracles: CBC mode encryption

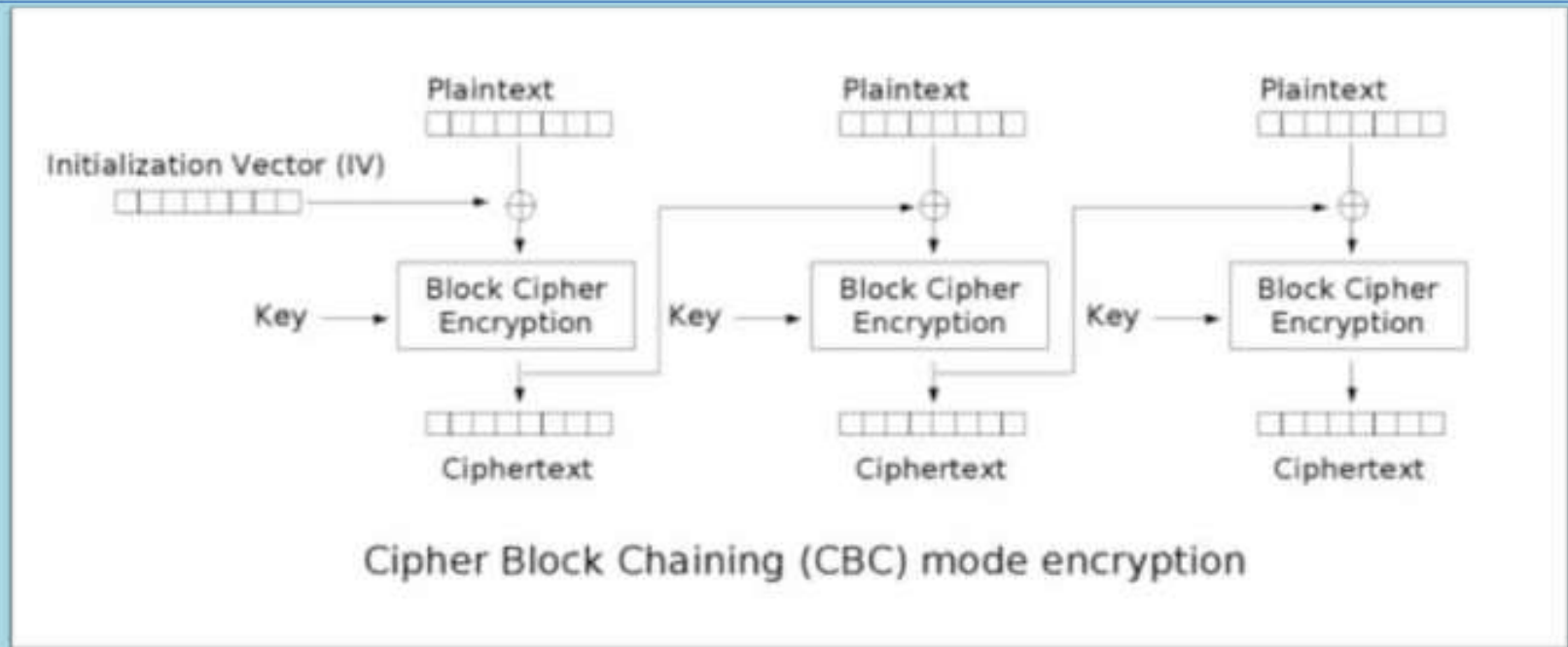

- For any given block of plaintext, P_n , the corresponding ciphertext, C_n , can be calculated as:

$$C_n = E(P_n \oplus C_{n-1})$$

- In other words, you XOR the plaintext with the previous ciphertext, then encrypt it

Padding oracles: CBC mode decryption

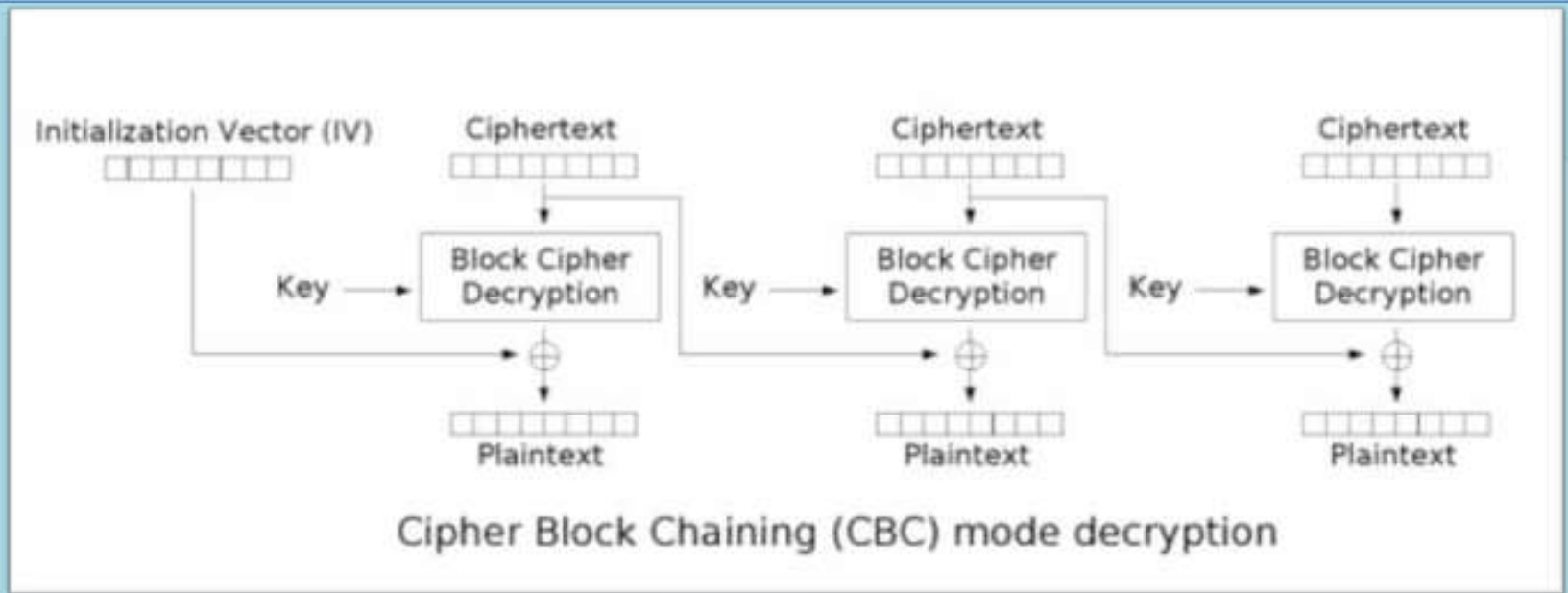

- For any given block of ciphertext, C_n , we can calculate the corresponding plaintext, P_n , as:

$$P_n = D(C_n) \oplus C_{n-1}$$

- In other words, the ciphertext is decrypted, then XORed with the previous ciphertext

Padding oracles

- So, we have two formulas:

$$C_n = E(P_n \oplus C_{n-1})$$
$$P_n = D(C_n) \oplus C_{n-1}$$

- We can verify these make sense by encrypting and decrypting a block:

$$P_n = D(E(P_n \oplus C_{n-1})) \oplus C_{n-1}$$

$$P_n = P_n \oplus C_{n-1} \oplus C_{n-1}$$

$$P_n = P_n$$

Decrypt the encrypted data

Two XORs cancel out

Success!

Padding oracles

- Encryption steps...

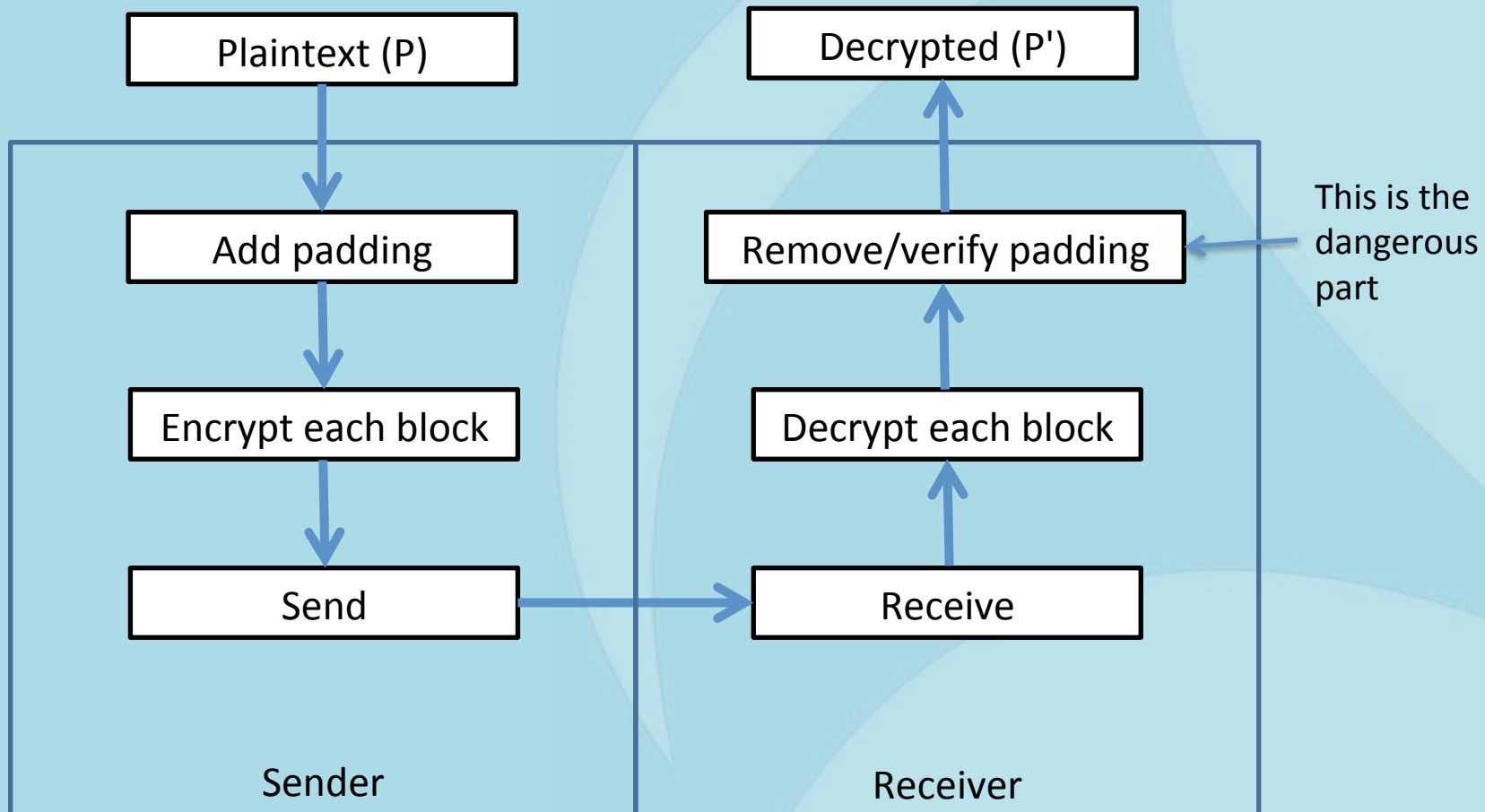

Padding oracles

- Let's start with how this is "supposed" to work
 - Example string: "Hello World"
 - **P** = "Hello World"

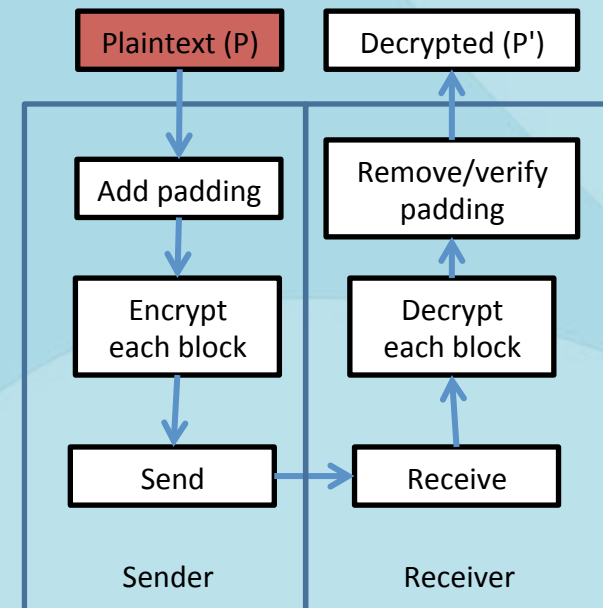

Padding oracles

- Adding padding
 - "Hello World" is 11 characters
 - With a blocksize of 8, that means we have one full block ("Hello Wo"), and one block of 3 characters ("rld")
 - Therefore, we need 5 bytes of padding

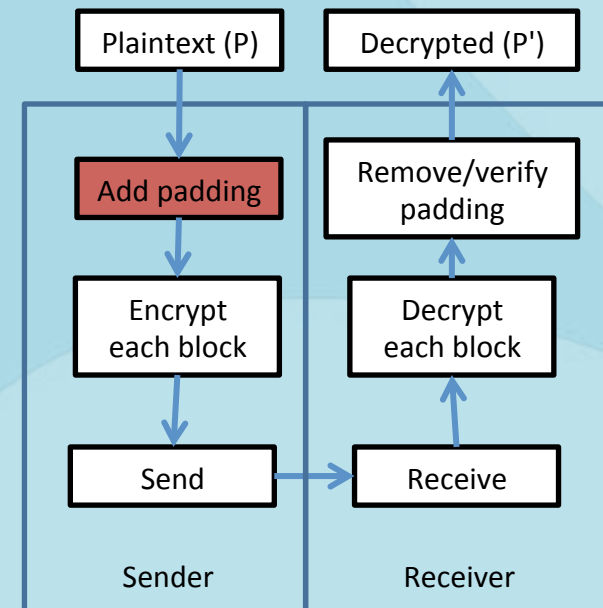
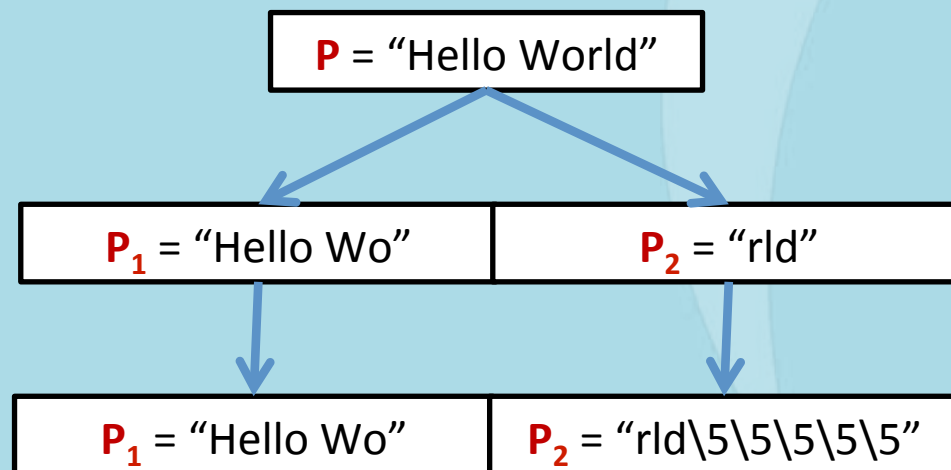

Padding oracles

- P_1 is encrypted to become C_1
- P_2 is encrypted, then XORed with C_1 , to become C_2 .
- C_1 and C_2 are combined to make C .

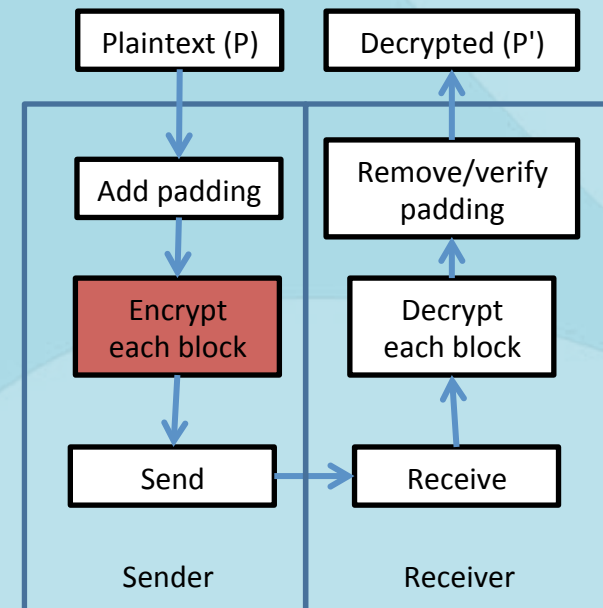
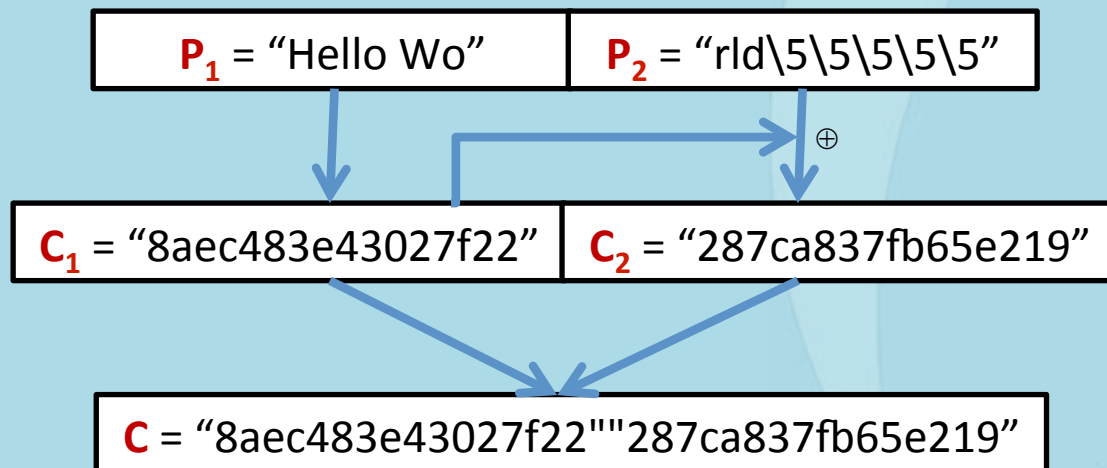

Padding oracles

- The ciphertext – **C** – is transmitted to the (possibly malicious) user
- It's important to remember that while the user can store it and send it back to the server, the user **cannot decrypt it**

C = "8aec483e43027f22""287ca837fb65e219"

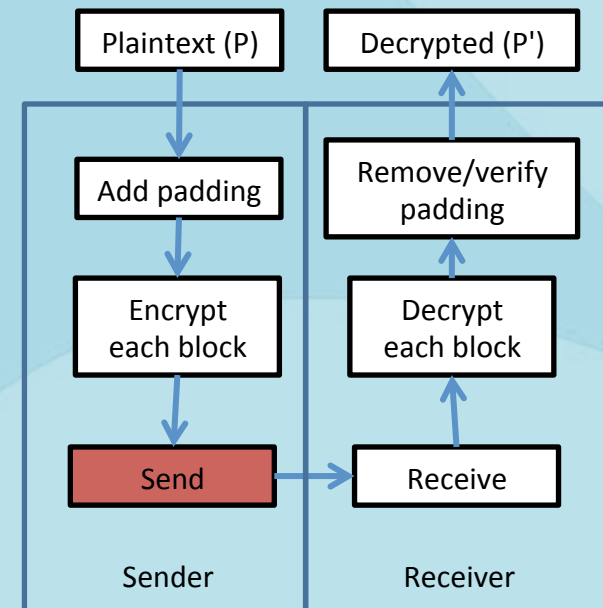
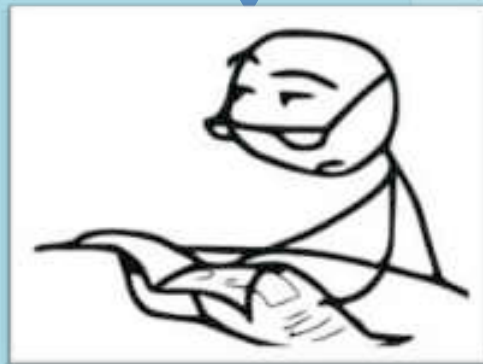

Padding oracles

- At some point in the future, the user will return the encrypted data to the server
- This is where the attack and normal usage diverge, as we'll see

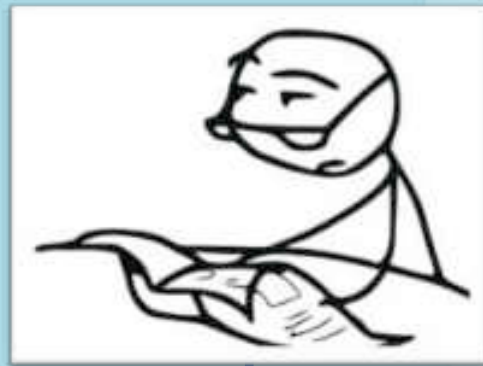

C' = "8aec483e43027f22""287ca837fb65e219"

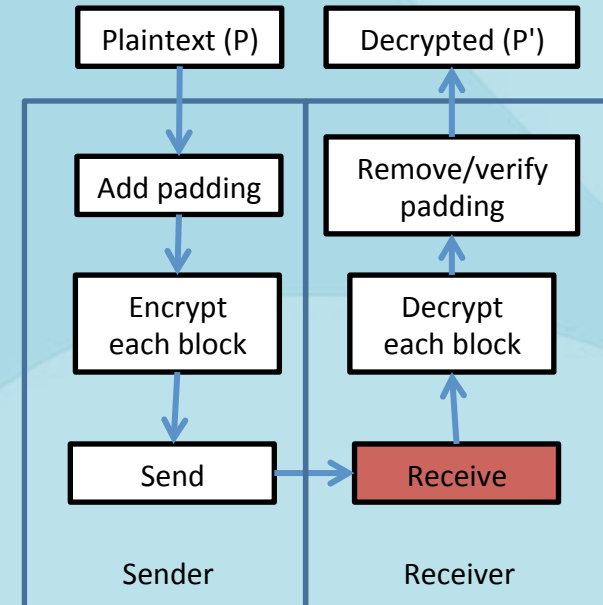

Padding oracles

- The server breaks C' back into C'_1 and C'_2
- C'_2 is decrypted then XORed with C'_1
 - Note: the server, at this point, *doesn't know if valid data was produced*

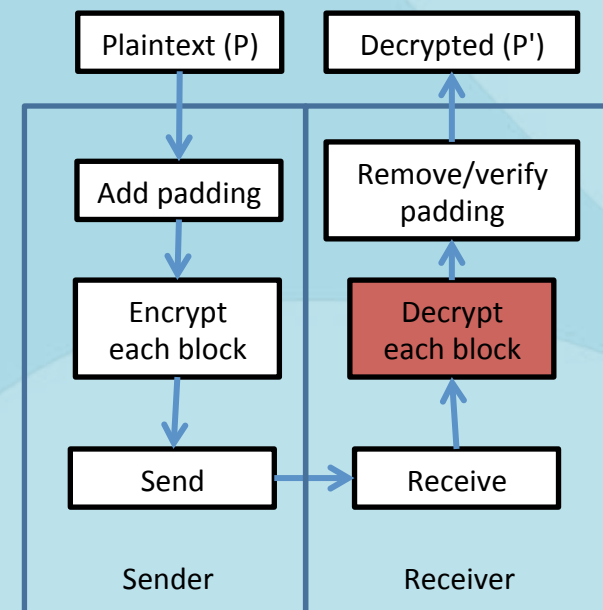
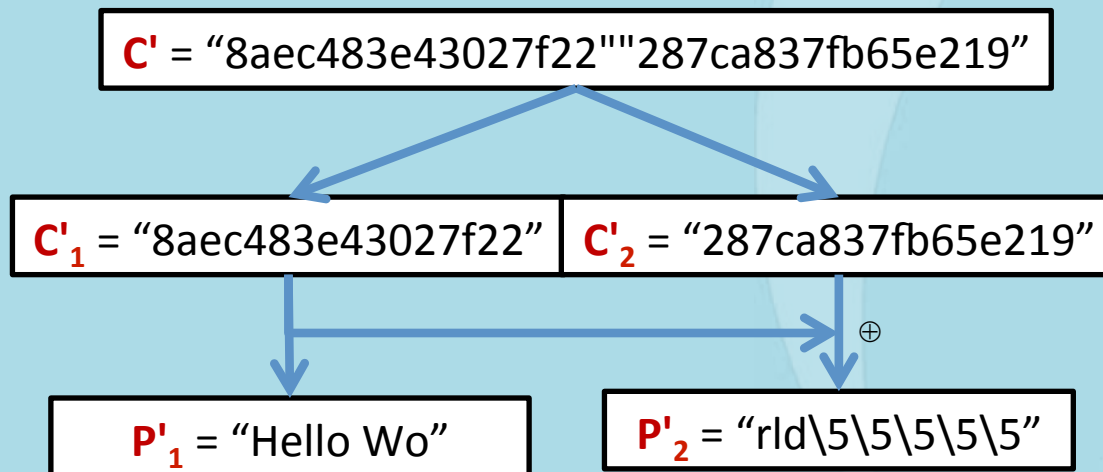

Padding oracles

- The server looks at the last byte of the last block – “\5” – and verifies that the last 5 bytes are all equal to “\5” – otherwise, the padding is wrong
- Once padding is verified, it's removed and the blocks are reunited
- This is *all that's done* to verify that the data decrypted properly

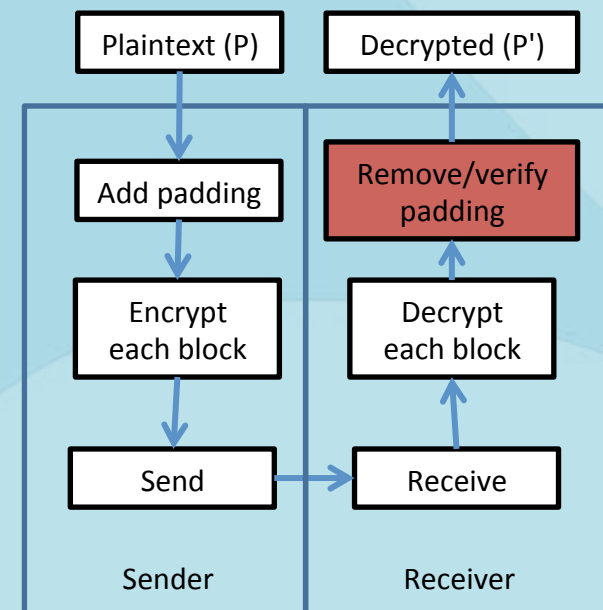
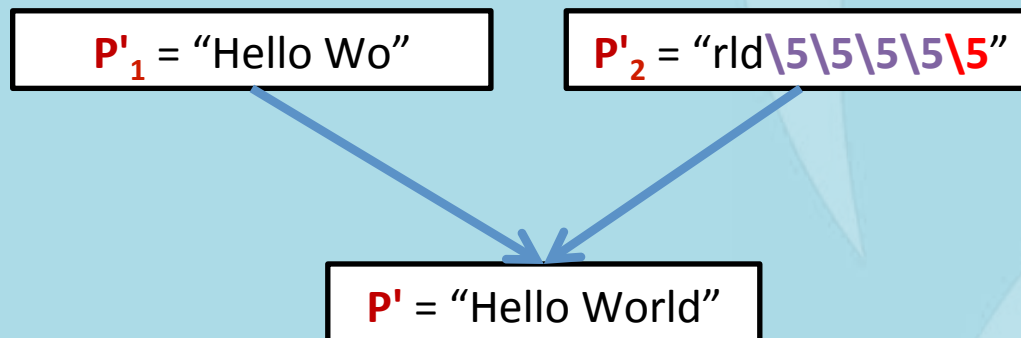

Padding oracles

- And now, we're back where we started
 - $P' = P$, as it's supposed to

$P' = \text{"Hello World"}$

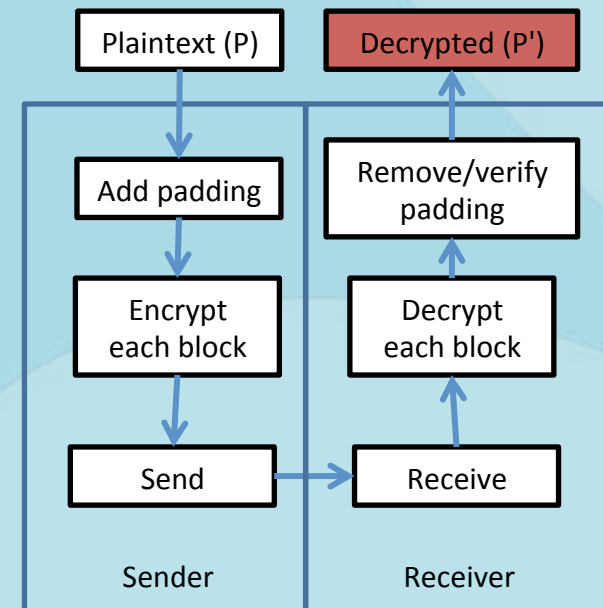

Padding oracles

- Now let's look at an example of how we can attack this...

Padding oracles

- Here are the first three steps again, same as last time

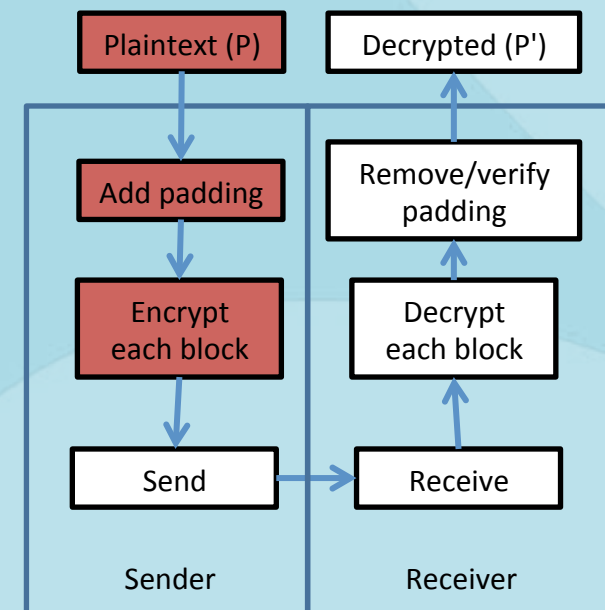
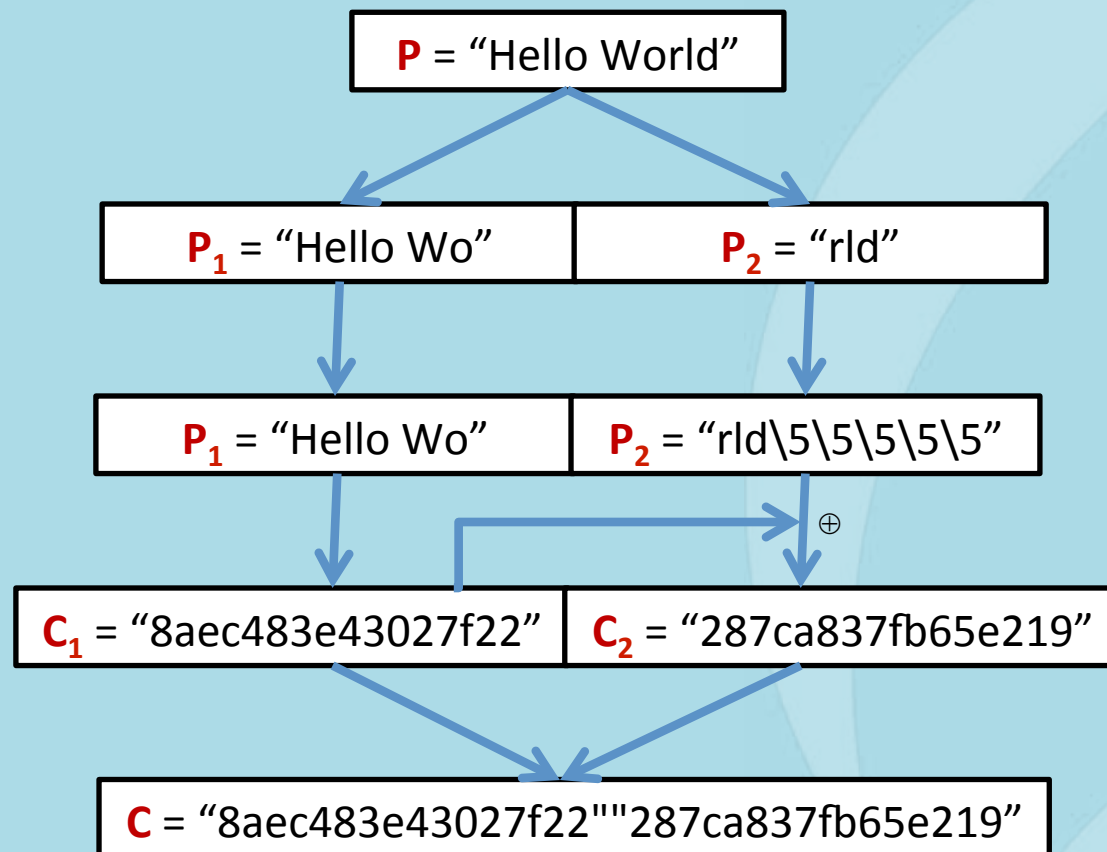

Padding oracles

- This time, the data is sent to a malicious user, such as Eve
- As before, Eve cannot decrypt this. But she *wants* to, and will find a way!

C = "8aec483e43027f22""287ca837fb65e219"

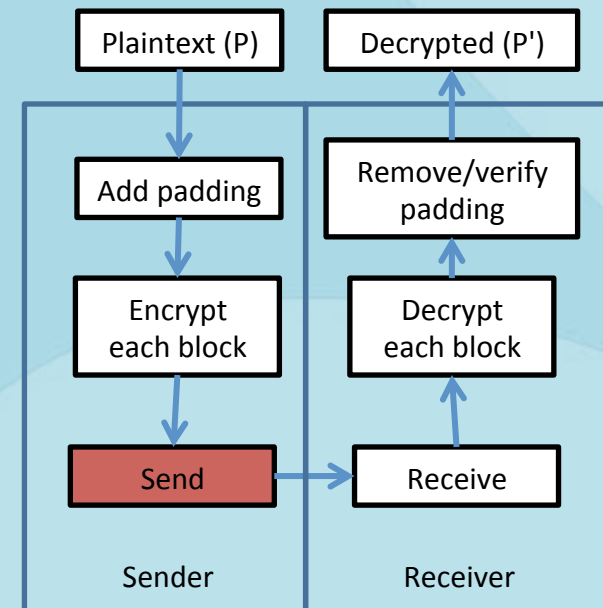

Padding oracles

- Eve is going to focus only on the second half of the cipher, C_2 (note that this can apply to any block)

$C'_2 = "287ca837fb65e219"$

- She generates a brand new block for C'_1 , then prepends it to C_2 to form C'_2

$C'_1 = "00000000000000000000"$ $C'_2 = "287ca837fb65e219"$

Used all zeroes for convenience – not necessary

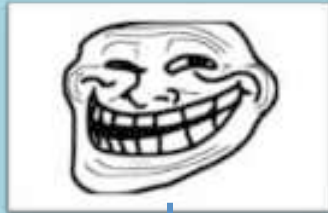

$C' = "00000000000000000000" + "287ca837fb65e219"$

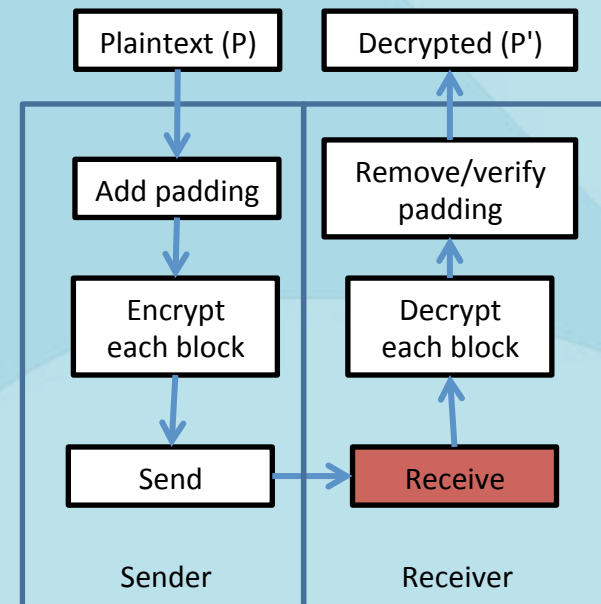

Padding oracles

- Now, what happens when the server tries to decrypt this new C' ?
- Remember, C'_2 is XORed with C'_1 after it's decrypted

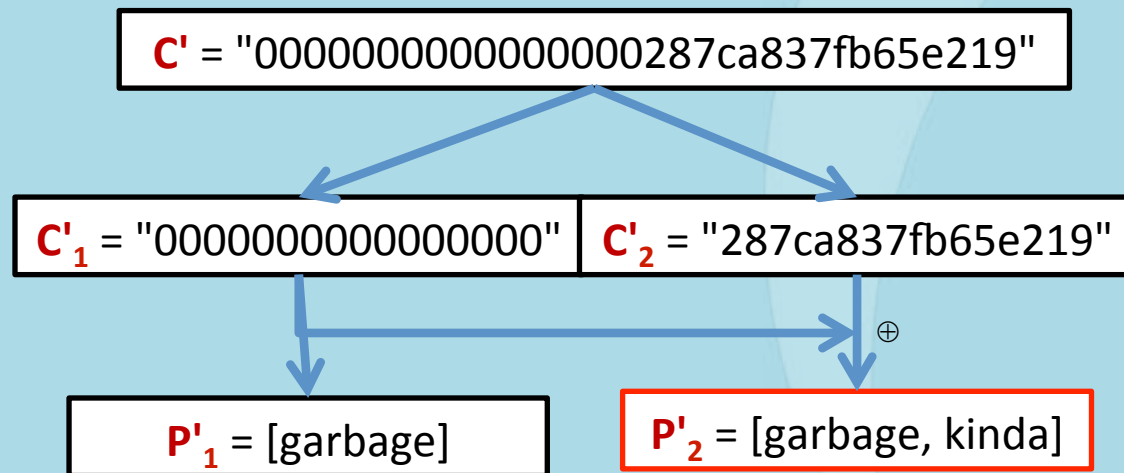

Let's take a closer look at P'_2 ...

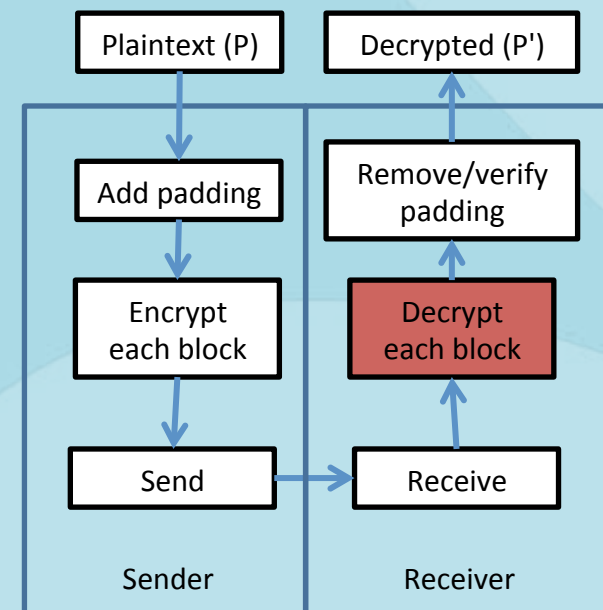

Padding oracles

- Recall our decryption formula:

$$P_n = D(C_n) \oplus C_{n-1}$$

$$P_2 = D(C'_2) \oplus C'_1$$

$C'_1 = "0000000000000000"$

$C'_2 = "287ca837fb65e219"$

- So C'_2 is being decrypted in the usual way, *then XORed with C'_1* instead of with the actual C_1 !
- Instead of undoing the original XOR, it's adding another XOR layer:

$$P'_2 = P_2 \oplus C_1 \oplus C'_1$$

$$P'_2 \neq P_2$$

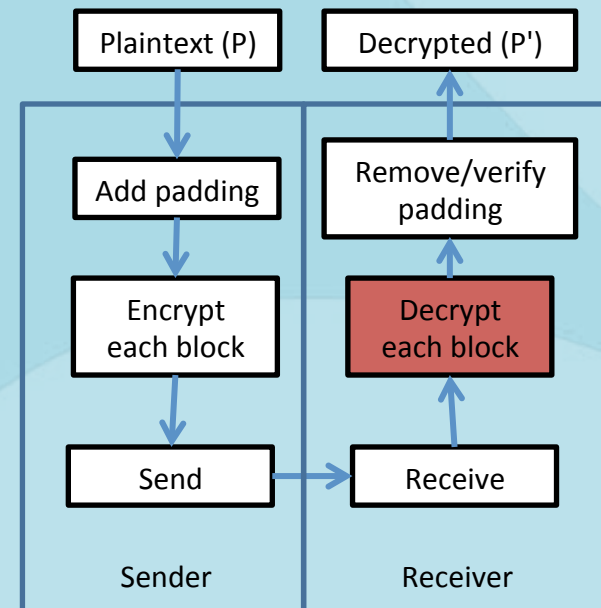

Padding oracles

- To put it another way...
- Original decryption:

$$\begin{aligned}P_n &= D(E(P_n \oplus C_{n-1})) \oplus C_{n-1} \\P_n &= P_n \oplus C_{n-1} \oplus C_{n-1} \\P_n &= P_n\end{aligned}$$

- New decryption:

$$\begin{aligned}P_n &= D(E(P_n \oplus C_{n-1})) \oplus C'_{n-1} \\P_n &= P_n \oplus C_{n-1} \oplus C'_{n-1}\end{aligned}$$

...can't reduce any further

Padding oracles

- So now we have this formula:

$$P'_2 = P_2 \oplus C_1 \oplus C'_1$$

- But what's it *mean*?
- The first thing we want to do is re-arrange it, because we want to solve for the original plaintext, P_2 :

$$P_2 = P'_2 \oplus C_1 \oplus C'_1$$

- This is legal, because

$$A \oplus B = B \oplus A$$

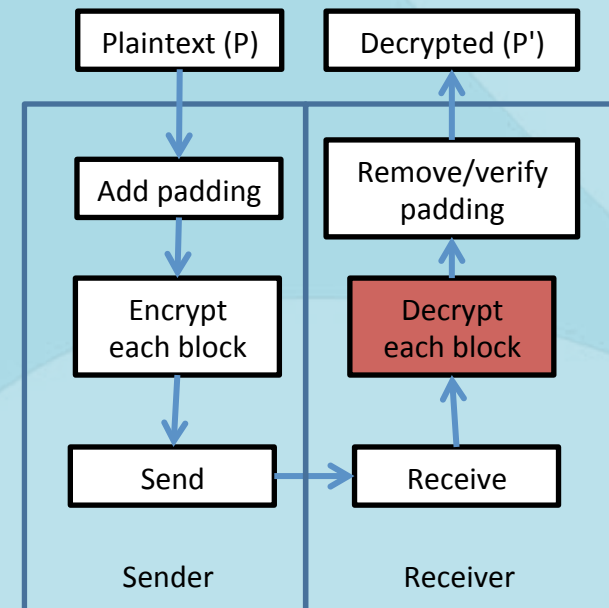

Padding oracles

$$P_2 = P'_2 \oplus C_1 \oplus C'_1$$

Here's that formula again. And here's what the terms mean:

P_2 = The original plaintext value (our goal)

P'_2 = The value the server calculates (mostly a garbage string)

C_1 = The previous ciphertext block (known to us)

C'_1 = The ciphertext block chosen by the attacker
("000000000000000000")

- We **control** C'_1 , and we **know** C_1 , but what about P_2 and P'_2 ?
- We have an equation with two unknowns!
 - Or do we?

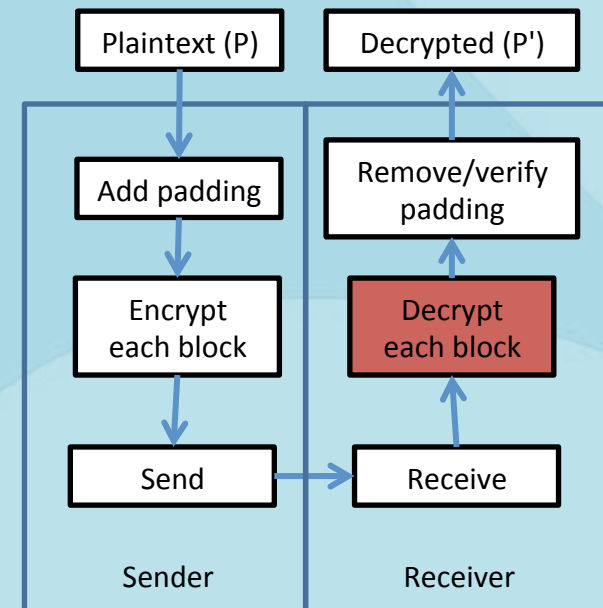

Padding oracles

$$P'_2 = P_2 \oplus C_1 \oplus C'_1$$

- Let's focus on P'_2 , and move on to the next step: Remove/verify padding
- If P'_2 decrypts to:
 - "[garbage]\x00" ← Bad padding
 - "[garbage]\x01" ← Good padding
 - "[garbage]\x02" ← Bad padding (probably*)
 - "[garbage]\x03" ← Bad padding
 - "[garbage]\x04" ← Bad padding
 - "[garbage]\x05" ← Bad padding
 -
- By definition – for this attack – the server tells us when the padding is good or bad

Let's ignore the rare case where the string happens to end with \x02\x02 or \x03\x03\x03 or ...

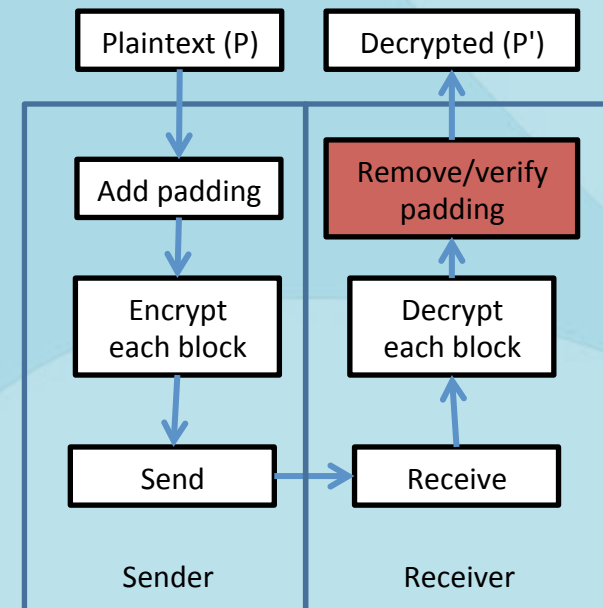

Padding oracles

$$P'_2 = P_2 \oplus C_1 \oplus C'_1$$

- What's this mean for our attack?
- As soon as the padding is correct, we know the last byte of the new plaintext (P'_2)
- That's big. That's HUGE!
 - Suddenly, our equation for the last byte of P_2 only has one unknown!
 - All we have to do is send 256 values for the last byte of C'_1 , and we're eventually going to get valid padding

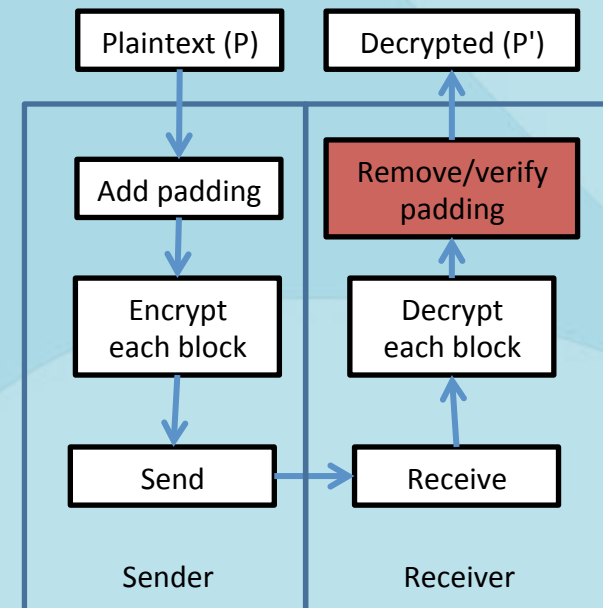

Padding oracles

- Let's only focus on the last bytes:

$$P_2[n] = P'_2[n] \oplus C_1[n] \oplus C'_1[n]$$

- To define everything again...
 - $P_2[n]$ = The last byte of plaintext (the value we want!)
 - $P'_2[n]$ = The last byte of what the server ends up decrypting (proper padding = "\x01")
 - $C_1[n]$ = The last byte of the original first block
 - $C'_1[n]$ = The last byte of the new first block
- We can now calculate $P_2[n]$!**

$$P_2[n] = 1 \oplus C_1[n] \oplus C'_1[n]$$

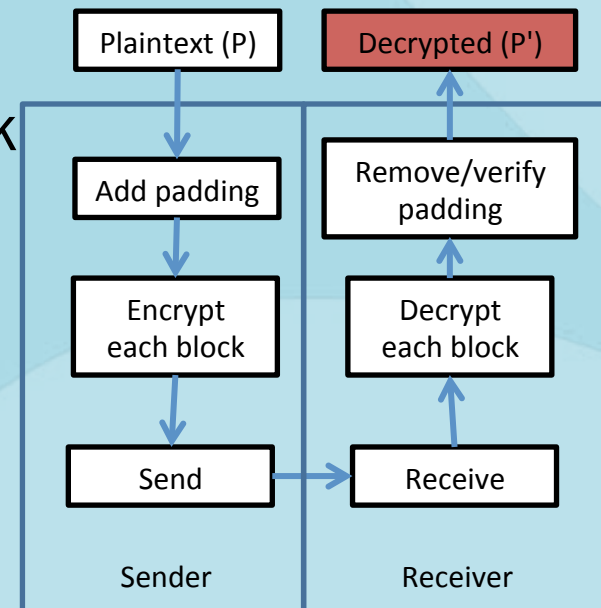

Padding oracles

- So, to summarize:

- Choose a new block, which we call C' , and prepend it to the block you're trying to decrypt:

| | |
|--------------------------------------|-----------------------------------|
| $C' = \text{"00000000000000000000"}$ | $C_2 = \text{"287ca837fb65e219"}$ |
|--------------------------------------|-----------------------------------|

- Change the last byte of C' until you stop getting a padding error:

| | |
|--------------------------------------|-----------------------------------|
| $C' = \text{"00000000000000000026"}$ | $C_2 = \text{"287ca837fb65e219"}$ |
|--------------------------------------|-----------------------------------|

- Plug it into the formula:

| |
|---|
| $P_2[n] = P'_2[n] \oplus C_1[n] \oplus C'_1[n]$ |
| $P_2[n] = 0x01 \oplus 0x22 \oplus 0x26$ |

- And solve!

| |
|-----------------|
| $P_2[N] = 0x05$ |
|-----------------|

Recall:
 $P_2 = \text{"rld\5\5\5\5\5"}$

Padding oracles

- By having the server tell us when the last byte of the decrypt block is right, we can trivially decrypt and encrypt it using only the XOR operation
- The last byte can be set to `\x02`, and the second-last byte can be guessed using the same formula
- The last and second-last bytes can be set to `\x03\x03`, and the third-last byte can be guessed using the same formula
- ...and so on, until the whole block is decrypted

Introducing: Poracle

- Like all these attacks, I wrote a tool
- This one's called "Poracle"



Padding oracles: Prevention

- How do you prevent padding oracles?
 - HMAC!
- By prepending an HMAC hash to the encrypted data – *and validating it before the decryption is performed* – you can check if anybody has tampered with the hash!
- You can also prevent this by using a block cipher mode of operation other than cipher-block chaining – eg, counter mode, output feedback, plaintext feedback, etc.

Almost there!



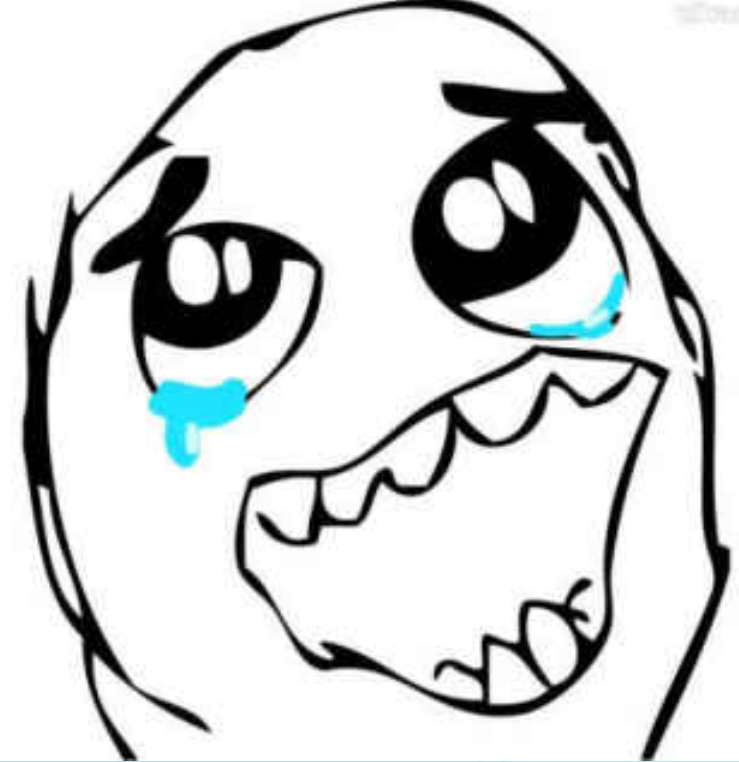
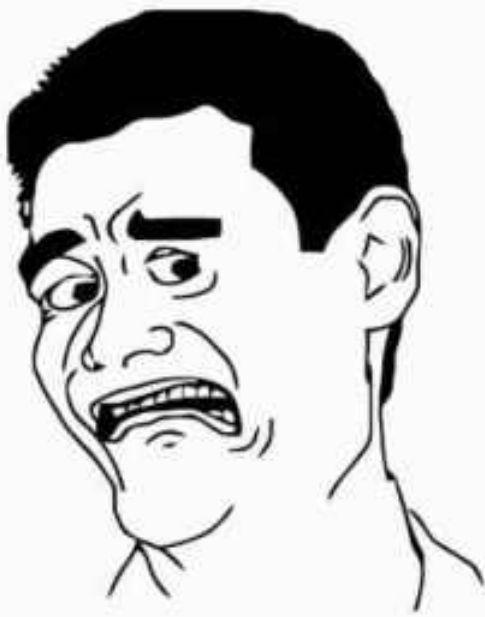

Because people get mad at me for just pointing out problems...

SOLUTIONS

Solution #1: don't give attackers encrypted data

- This isn't always possible
- When you can, give an index, a session, or something like that, rather than letting an attacker store state

Or, to put it another way...

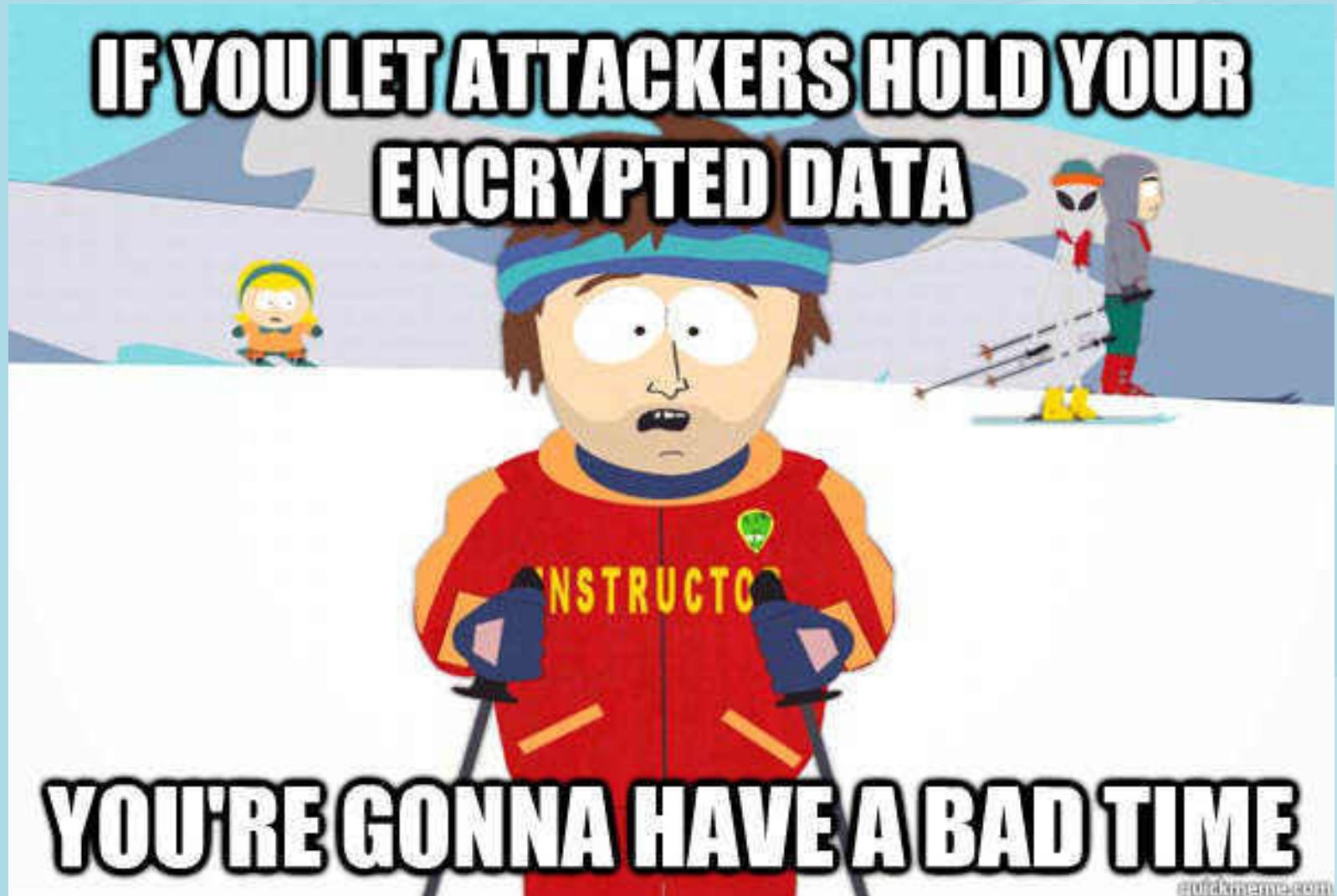

Solution #2: When you give them encrypted data, validate it

- “The cryptographic doom principle”
- Calculate a HMAC and send it with the encrypted data
 - Validate the HMAC before attempting to decrypt
- Alternatively, use authenticated encryption, for example, "GCM Mode"
- Coming soon: CAESAR
 - **CAESAR: Competition for Authenticated Encryption: Security, Applicability, and Robustness**

“The cryptographic doom principle”

IF YOU PERFORM ANY CRYPTOGRAPHIC OPERATIONS BEFORE VERIFYING THE HASH



Solution #3: Never encrypt data with the same key and IV

- Almost every cipher fails if you use the same key and IV
- Change keys when it makes sense, and change IVs *every time*

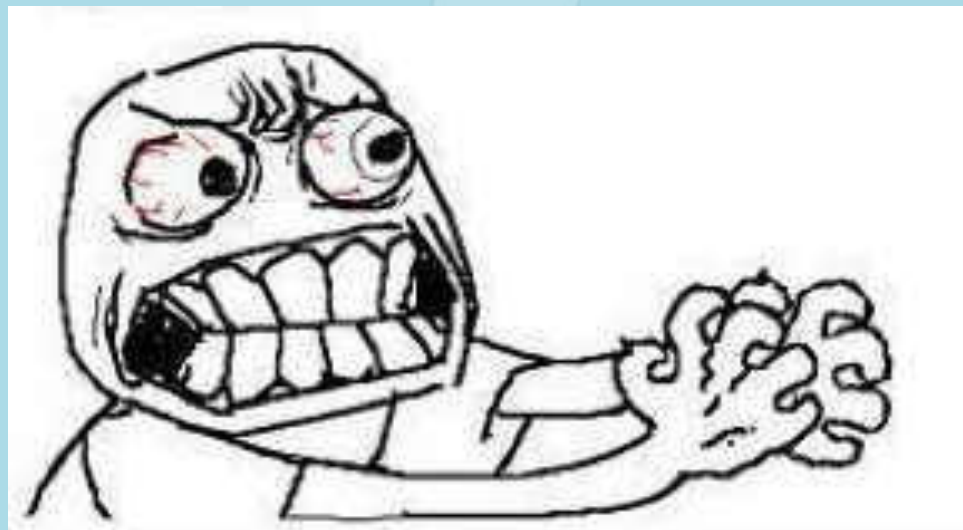

One last ski instructor, then we're done!

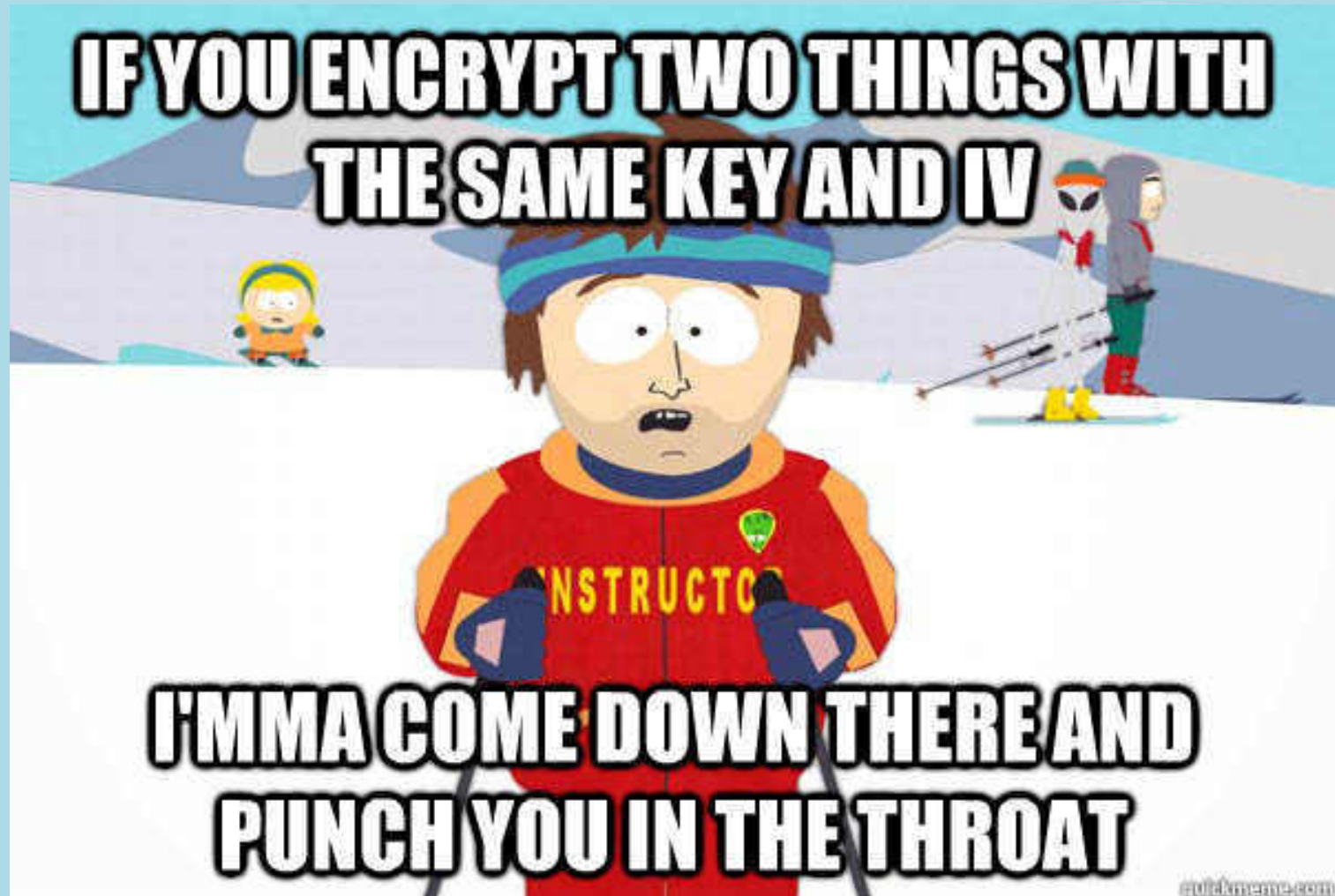



THAT'S ALL!

Links + Contact info

- Me:
 - Ron Bowes <ron.bowes@leviathansecurity.com>
 - @iagox86
 - <http://www.skullsecurity.org>
 - <http://www.leviathansecurity.com>
- Tools:
 - <https://www.github.com/iagox86/prephixer>
 - <https://www.github.com/iagox86/poracle>
 - https://www.github.com/iagox86/hash_extender
 - <https://www.github.com/iagox86/unzipher>
- This talk will be on <https://www.github.com/iagox86> as well